

# STANDARD SR-L555F

S71

Q1 2SA343  
FM-RF

Q2 2SA343  
FM-CONV

Q3 2SB175  
FM-AFC

Q4 2SA234  
FM-IF 1ST

Q5 2SA234  
FM-IF 2ND  
AM-IF 1ST

Q6 2SA234  
FM-IF 3RD  
AM-IF 2ND

Q11 2SB75  
AF-1ST

Q12 2SB75  
AF-2ND

Q13 2SB75  
DRIVER

Q14,15 2SB156X2  
POWER

Q16 2SA70  
AM CONV.

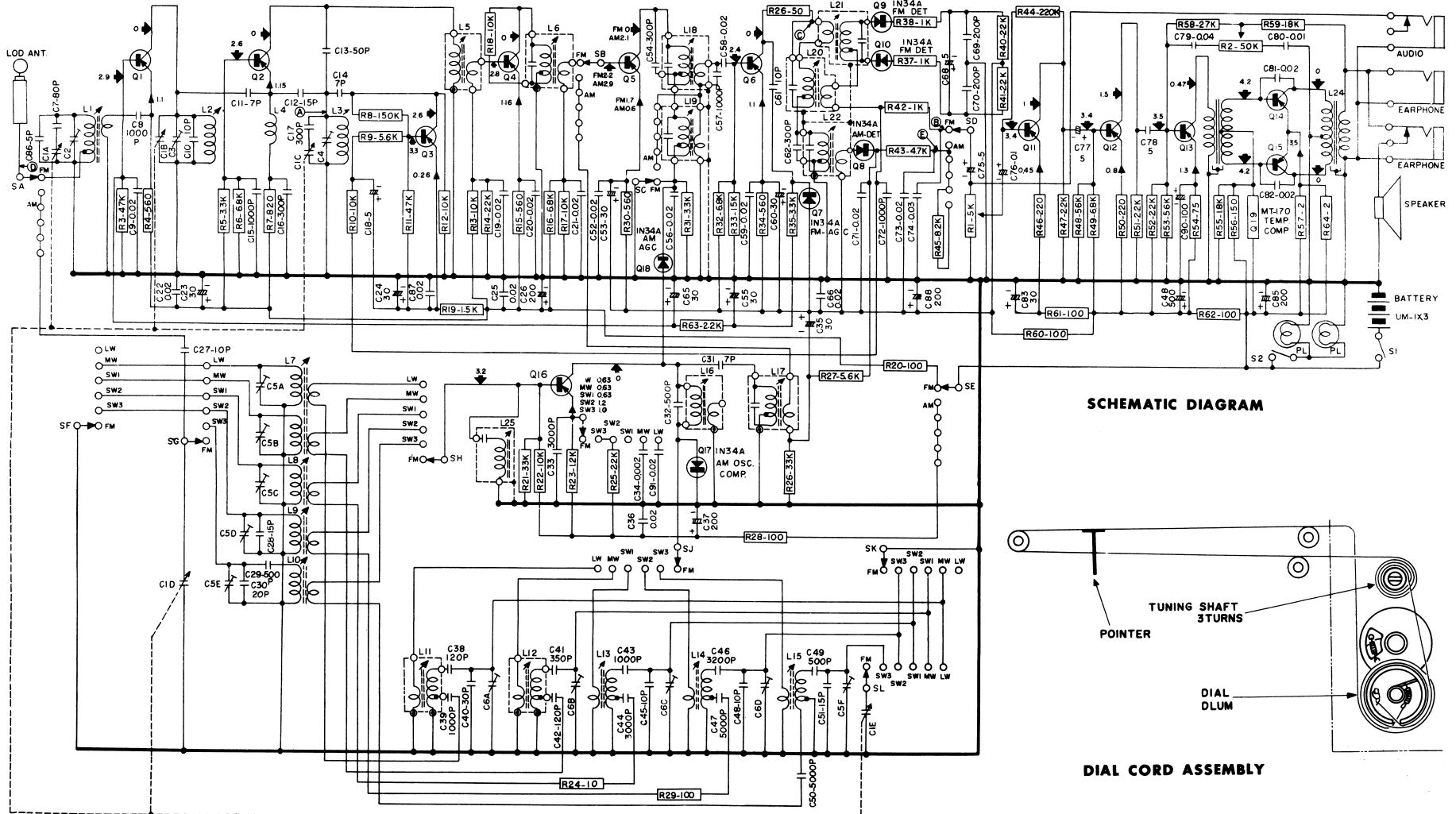

SCHEMATIC DIAGRAM

DIAL CORD ASSEMBLY

ANTENNA COIL (ANT.)

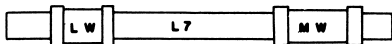

TRIMMER CAPACITOR

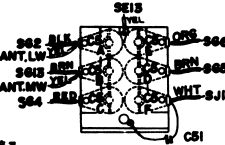

BAND SELECTOR SWITCH (S)

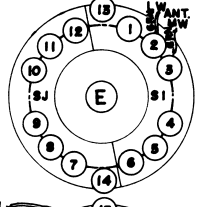
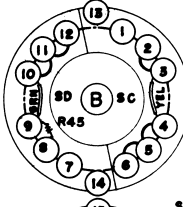
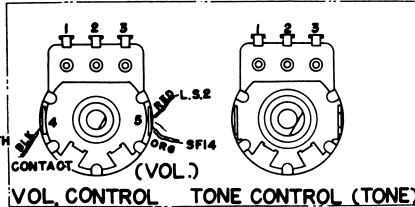
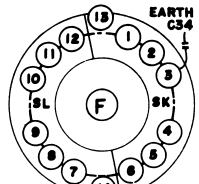
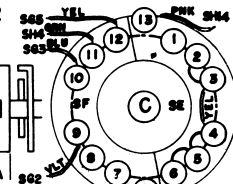
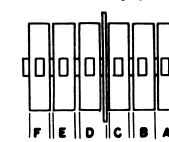

LAMP SWITCH (L.S.)

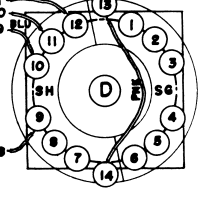
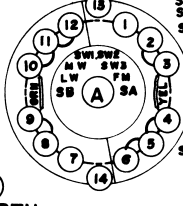
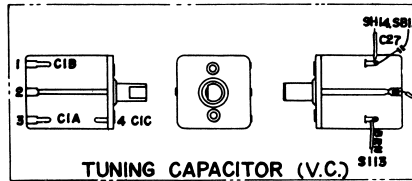
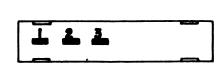

PILOT LAMP (A) (P.L.)

PILOT LAMP (B) (P.L.)

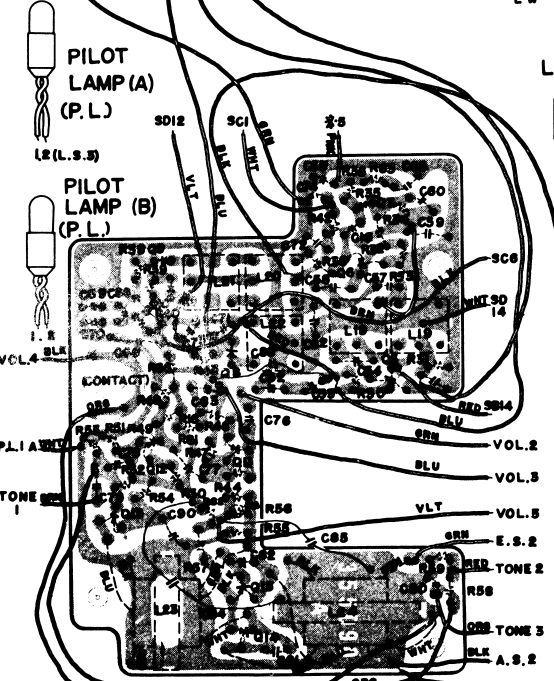

SPEAKER

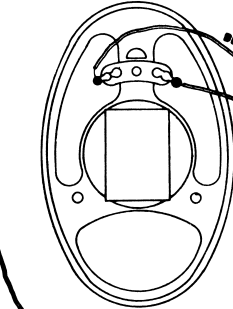

AUDIO SOCKET (A.S.)

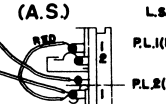

EARPHONE SOCKET (E.S.)



ROD ANTENNA

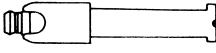

CIRCUIT BOARD DIAGRAM