

INSTRUCTION MANUAL
for
THE
NATIONAL MODEL
NC-57
RADIO RECEIVER

A fine Receiver in a compact, modern
package at an attractive low price...

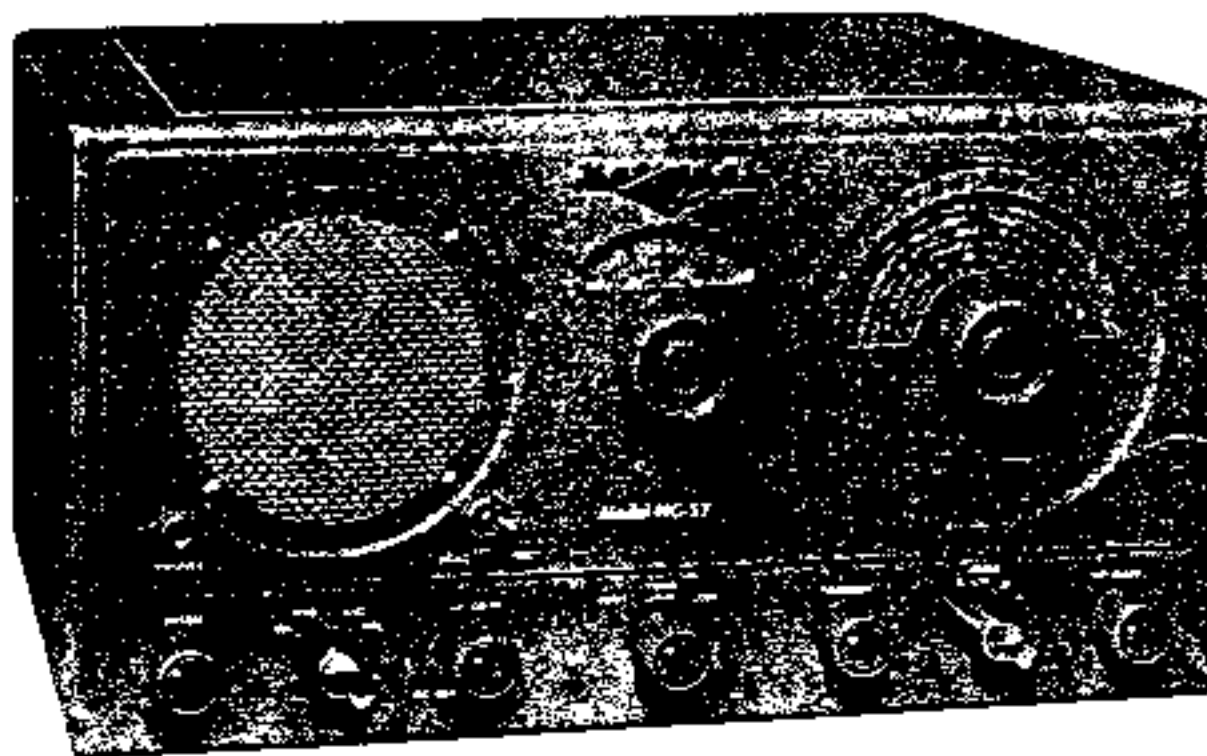

National



NC-57 RECEIVER

HIGHLIGHTS . . .

- Continuous Frequency Coverage of from 540 kilocycles to 54 megacycles
- Bandsread Tuning for All Frequencies
- Automatic Noise Limiter
- Accessory Connector Socket
- Stabilized Voltage Regulated Circuits
- R.F. Amplifier Stage with Panel Trimmer
- Two I.F. Amplifier Stages
- Built-In Loudspeaker and Power Supply

National Company, Inc.

THE NC-57 RADIO RECEIVER

SECTION I. DESCRIPTION

1-1. General

The NC-57 is a superhetrodyne Radio Receiver, having a complement of seven tubes plus a voltage regulator and rectifier, with a continuous frequency coverage of from 540 kilocycles to 54 megacycles. This Receiver is designed to provide reception of amplitude modulated voice or music and code telegraph signals throughout its entire frequency range. Operational controls mounted on the front panel are held to a minimum consistent with good operation and full utilization of the circuit features contained in the NC-57. The separate bandspread control knob and dial scale makes possible fine, vernier-type tuning for any portion of the frequency spectrum covered by the Receiver. The usefulness of this feature will be outstanding on crowded bands such as the amateur or foreign broadcast bands. The NC-57 employs a voltage regulator tube to assure a high order of stability in the high frequency and beat frequency oscillator circuits.

1-2. Circuit

A stage outline of the circuit employed in the NC-57 is given below together with the tube associated with each stage.

R. F. Amplifier.....	6SG7
Converter.....	6SB7-Y
First I. F. Amplifier.....	6SG7
Second I. F. Amplifier.....	6SG7
Second Det. - A. V. C. - A. N. L.....	6H6
First Audio - C. W. O.....	6SL7GT
Audio Output.....	6V6GT/G
Voltage Regulator.....	OD3/VR-150
Rectifier.....	5Y3GT/G

1-3. Tuning System

The three-gang main tuning capacitor, the panel-mounted Trimmer control and five sets of coils are used to tune the frequency range of the Receiver in five tuning bands as shown on the following table. The main tuning capacitor and bandspread capacitor are connected in parallel on all bands.

BAND	FREQUENCY COVERAGE
A	35.0 - 54.0 Mc.
B	12.0 - 35.0 Mc.
C	4.4 - 12.0 Mc.
D	1.55 - 4.4 Mc.
E	0.56 - 1.55 Mc.

It will be noted that Band E encompasses the entire Standard Broadcast Band,

The Amateur bands tuneable by the NC-57 are listed below with their respective receiver band locations and are spread on the bandspread dial by means of the bandspread capacitor approximately as follows:

BAND	AMATEUR BAND	FREQUENCY	DIVISIONS
A	6	50.0 - 54.0 Mc.	37
B	10, 11	27.16- 29.7 Mc.	44
	15	21.0 - 21.5 Mc.	28
	20	14.0 - 14.4 Mc.	65
C	40	7.0 - 7.3 Mc.	47
D	80	3.5 - 4.0 Mc.	60

The main dial has five scales accurately calibrated directly in megacycles. The respective scales are marked with heavy black scorings to clearly locate for the operator such short-wave features as the Amateur, Police and Foreign Broadcast bands. These locating markers are identified by letters AM, P and F, respectively.

1-4. Audio Output

Two audio output circuits are provided:

(1) The loudspeaker in the NC-57 is a 5 inch PM type capable of faithfully reproducing the ample audio volume delivered by the Receiver. An output transformer is mounted on the loudspeaker to match the impedance of the output tube.

(2) A Phones jack is mounted on the front panel and is wired so as to silence the loudspeaker when headphones are used. The headphone load impedance is not critical permitting a wide range of headphones types, including crystal, to be used.

1-5. Power Supply

The NC-57 Receiver is designed for operation from a 105/130 volt, 50/60 cycle, source of supply. Normal power consumption is approximately 84 watts. The built-in power supply provides all voltages required by the heater and B supply circuits - 2.7 amperes at 6.3 volts and 100 milliamperes at 250 volts, respectively.

The NC-57 is readily adaptable to battery operation and instructions for using batteries are given in detail in Section 2.

1-6. Accessory Connector Socket

An octal type socket is mounted at the

rear of the NC-57 to permit convenient connection of external accessories. The Tuning Meter, SM-57, which is available for use with the NC-57, is fitted with a cable and plug to connect directly to this socket. Varied accessories such as a crystal calibrator or record player are readily connected to the socket. When a record player is connected to the NC-57, the R. F. GAIN control should be set at the extreme counterclockwise position. The drawing of the Accessory Connector Socket on the Schematic Diagram shows the various connections made to the pins of the socket and the voltages available. As will be noted B plus and filament voltages are available at pins 2 and 3, respectively.

SECTION 2. INSTALLATION**2-1. Installation Procedure**

Carefully unpack the Receiver from its packing crate and proceed as follows:

(1) Make sure A.C. jumper plug, P-1, (at rear of Receiver) and all tubes are seated firmly in their sockets.

(2) Connect a good external ground to the terminal labeled G on the antenna ground strip at the rear of the Receiver. This connection is not absolutely required but in certain localities considerable reduction in interfering noise can be achieved by such a connection.

(3) Connect the antenna as recommended in Section 2-3.

(4) Connect the power cord, P-2,

to a 105/130 volt, 50/60 cycle, A.C. source of supply.

(5) Set controls as recommended in Section 3 for the reception of signals.

NOTE

Where the Receiver is located in the field of a transmitting station, as would be the case when the NC-57 is used as the Receiver in a transmitting station, it is advisable to provide some means of preventing damage to the receiver antenna coil. If a separate receiving antenna is used, a means for disconnecting the antenna from the Receiver or grounding the antenna during transmission periods should be provided.

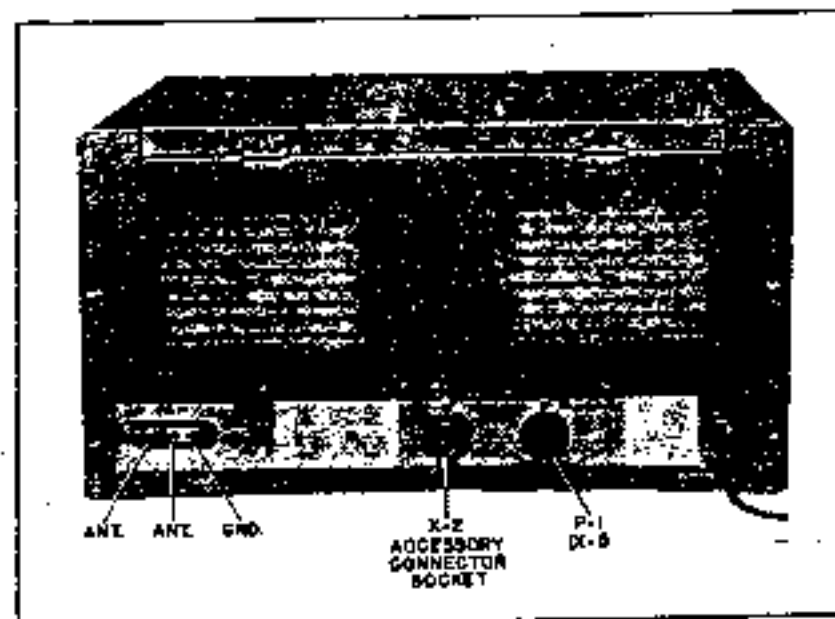

Figure No. 1. Rear View of Receiver

2-2. Battery Operation

The NC-57 Receiver is readily adaptable to portable or emergency service by connecting batteries to the terminals of the power socket, X-1, at the rear of the Receiver. The A.C. jumper plug, P-1, may be rewired for battery connection or if changeover operation is desired another octal plug should be obtained. Do not use the A.C. jumper plug, P-1, for battery operation without first removing the jumper wires. The battery plug used should be wired in accordance with the drawing shown on the schematic diagram. The voltage regulator tube should be removed during battery operation. A 6 volt heater supply (storage battery) should be connected to terminals 3 and 5 and 180 to 250 volt "B" supply connected to terminals 1 and 8. Current drain is approximately 70 milliamperes and 2.65 amperes at 180 and 6 volts, respectively. A suggested refinement is to include a switch in the A+ lead so that the tube heaters may be turned off when the Receiver is not in use without the necessity of removing the battery plug. The Send-Receive switch on the Receiver is operative with battery operation the same as for A.C. operation. The A.C. line switch on the front panel does not render the Receiver inoperative during battery operation.

The recommendations of Section 3, Operation, apply to the battery powered NC-57.

2-3. Antenna Recommendations

The antenna input circuit of the NC-57 is arranged for operation from either a single-wire type, doublet type antenna or

other types having impedances of 70 ohms or more. The input impedance of the antenna circuit is approximately 300 ohms.

The most practical antenna for use in installations where the Receiver is to be used over a wide range of frequencies is the single-wire type. An antenna length of 50 to 100 feet is recommended although the length is not critical and any length between 25 and 200 feet may be used. In installations where the Receiver is tuned to one frequency or narrow band of frequencies optimum results will be obtained by designing the antenna for the operating frequency. In an installation where the Receiver is to be used as the receiving unit, in a transmitting station, the most efficient operation will usually result from use of the transmitting antenna as a receiving antenna also. For switching the antenna from transmitter to receiver, an antenna change-over relay with good high frequency insulation is recommended.

The method of connecting the various types of antennae to the antenna terminal strip at the rear of the Receiver is as follows:

- (1) Single-wire type -- Connect antenna to terminal A at the left of the strip and ground the unused A terminal by means of the metal link.
- (2) Doublet type -- Connect the antenna feeders to the two terminals marked A; the metal link is not used.
- (3) Concentric transmission line type -- Connect the inner conductor to terminal A at the left of the strip and the outer conductor to the other A terminal which, in turn, should be connected to the metal link.

SECTION 3. OPERATION

3-1. Controls

This section on controls is presented prior to the actual operating instructions to give the operator of an NC-57 an understanding of the function of each control on the Receiver. All controls are clearly identified by front panel markings and are arranged in a manner to facilitate operation.

tion.

The R.F. GAIN control adjusts the sensitivity (ability to receive weak and distant stations) of the Receiver from a minimum at the extreme counterclockwise position of the knob to a maximum at the extreme clockwise position. This is accomplished by adjustment of the amplification of the R.F. and I.F. amplifier stages.

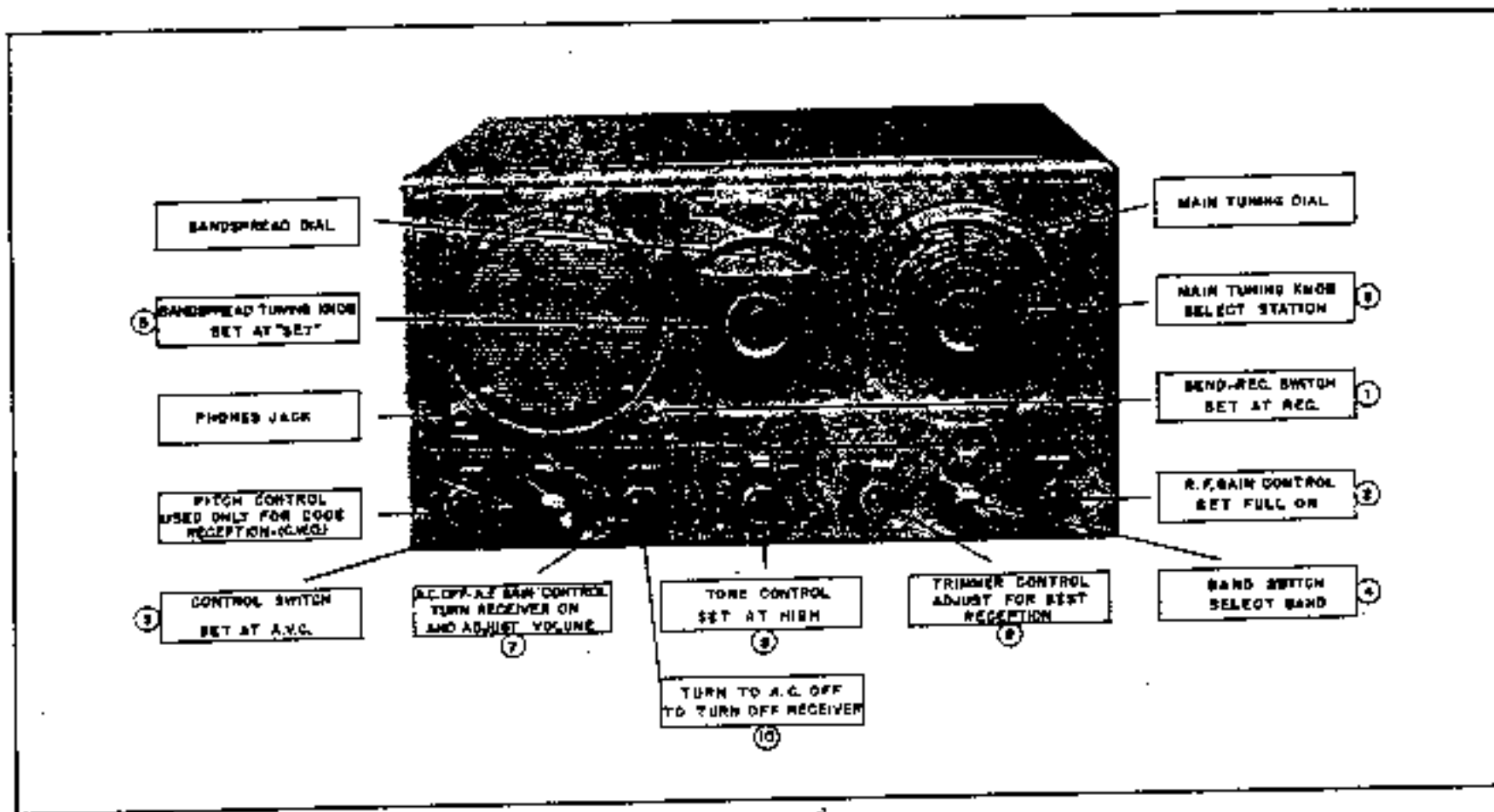

Figure No. 2. Simplified Operating Instructions

The BAND switch has five positions and serves to select the band of frequencies to be tuned by the Receiver. The five positions are marked with identifying band designations which correspond to the markings which appear on the main tuning dial.

The TRIMMER control operates a tuning capacitor trimmer which is connected across the first R.F. amplifier main tuning capacitor section. The trimmer control is used to tune the R.F. amplifier stage properly under a wide variety of antenna loading conditions.

The TONE control adjusts the tonal value of the audio output of the Receiver. The three positions select a tonal output as follows: High--normal receiver reproduction in which an average tonal output is achieved; Med--reproduction in which the higher tones are moderately attenuated; Low--in this position the higher tones are subdued emphasizing the lower tones.

The A.F. GAIN-A.C. OFF control is a dual purpose type. In the A.C. OFF position the Receiver is turned off; when the control knob is turned clockwise the A.C. line switch is closed, thus turning on the Receiver. The other function of this control is to adjust the audio output vol-

ume of the Receiver. Audio volume is progressively increased to a maximum when the knob is turned to the extreme clockwise position.

The control switch labeled C.W.O., M.V.C., A.V.C. and A.N.L. has four functions corresponding to the switch markings. In the A.V.C. position the automatic volume circuit is switched into the circuit to compensate for fluctuating volume due to fading. In the A.N.L. position the automatic noise limiter is switched on to effectively reduce interference caused by static, automobile ignition noise etc. Limiting action automatically takes place at a relatively high percentage modulation. The automatic volume control circuit remains operative in the A.N.L. position of the control switch. The M.V.C. position disables the A.V.C., C.W.O. and A.N.L. circuits. The C.W.O. position switches into the circuit the C.W. oscillator to permit reception of code telegraph signals.

The PITCH control is used in conjunction with the C.W.O. position of the control switch and has no effect on receiver performance with any other control switch setting. The PITCH control is used to adjust the beat note of the incoming code signal to an audio tone pleasing

to the operator. The C.W. oscillator is tuned to the Receiver's intermediate frequency mid-scale on the control knob. The range of the PITCH control is approximately $\pm 3,000$ cycles.

The SEND-RECEIVE switch is used to quiet the Receiver during transmission periods or other times when it is desirable to be able to resume reception immediately after a period of silence (i.e. not having to wait for the tubes to warm up). The SEND-RECEIVE switch should not be used to shut off the Receiver. The Receiver should be turned off by turning the A.F. GAIN control to A.C. OFF position. The function of the SEND-RECEIVE switch may be duplicated at an external (remote) position by connecting a switch or relay to terminals 5 and 8 of the A.C. jumper plug (P-1). This is a parallel arrangement permitting the panel-mounted SEND-RECEIVE switch to remain operative.

The main tuning control knob and dial scale are used to tune the frequency range of the Receiver. The band of frequencies tuned at any one time is determined by the BAND switch setting. To maintain correct calibration when using the main tuning knob the bandspread dial pointer must be at the "set" mark (located at 100 on the bandspread dial scale).

The bandspread control knob and dial scale are used to spread out over a wide range any small portion of the frequency range of the Receiver. Bandspread tuning is accomplished by setting the main tuning dial pointer at the high-frequency limit of the band of frequencies to be spread (for example: to tune the amateur 10 meter band set the pointer at 29.7 megacycles on the B band) and rotate the bandspread knob in a clockwise direction.

3-2. Voice or Music Reception

After the NC-57 Receiver is properly installed, as outlined in Section 2, it is placed in operation by adjusting the receiver controls as follows:

1. Set the SEND-RECEIVE switch at Receive.
2. Turn the R.F. GAIN control to the extreme clockwise position.
3. Set the control switch at A.V.C.
4. Set the BAND switch at the

band of frequencies to be tuned. The Standard Broadcast Band is band E.

5. Set the bandspread dial pointer at the "Set" mark.

6. Set the main tuning dial pointer at the desired frequency.

7. Turn the A.F. GAIN-A.C. OFF control from the A.C. OFF position to the point providing the desired audio volume. Reset main tuning dial pointer if necessary.

8. Set the TONE control at High.

9. Set the TRIMMER control for maximum response. Maximum response is clearly indicated by use of the SM-57 Tuning Meter; the correct setting of the TRIMMER control is indicated by maximum deflection of SM-57 meter pointer. In order to secure a good aural indication of the correct TRIMMER setting, if the SM-57 is not used, it is recommended that the control switch be set at M.V.C. temporarily to adjust the TRIMMER control. In this case it may be necessary to retard the R.F. GAIN control if overload of the Receiver occurs, as will be indicated by excessive distortion. In the absence of signals the trimmer control may be "peaked" by setting it for maximum receiver background noise.

The settings given above are for the reception of signals of average strength. An improvement in the reception of exceptionally weak signals or signals accompanied by interfering noise pulses may be realized by modification of the above settings.

For improvement in the reception of weak signals set the control switch at M.V.C. and modify the other control settings as follows:

1. Set the A.F. GAIN control at approximately three-quarters rotation.
2. Adjust the audio volume by means of the R.F. GAIN control.

When a signal is accompanied by static peaks or noise pulses of high intensity and short duration, optimum noise-free reception will be had by setting the control switch at A.N.L. The resulting automatic limiting action will greatly reduce the interfering noise without noticeably affecting the signal. Best limiting action will be realized with the R.F. GAIN control

fully advanced; the audio volume should be adjusted by means of the A.F. GAIN control. A further improvement in noise reduction will be realized by setting the TONE switch at Med. or Low depending on the degree of noise.

3-3. Code Telegraphy Reception

The adjustment of the receiver controls for code reception is the same as that for voice or music except for the fol-

lowing:

1. Set the control switch at C.W.O.
2. Set the A.F. GAIN control at three-quarters rotation.
3. Adjust the audio volume by means of the R.F. GAIN control.
4. Adjust the PITCH control to secure an audio tone pleasing to copy.

The action of the TONE control is the same as that described in Section 3-2.

SECTION 4. MAINTENANCE AND TEST DATA

4-1. General Maintenance Data

The NC-57 is designed and constructed to assure a long period of uninterrupted service. A few service hints are given below to aid in locating individual components which, due to age or weakness, cause faulty operation of the Receiver.

Vacuum tube failure may be evidenced by reduction in sensitivity, intermittent operation or an inoperative Receiver. Tubes may be checked in suitable tube testing equipment, or by replacement with tubes of proven quality. Care must be taken that tubes removed for checking are returned to their original sockets. Tubes of

the same type will vary slightly in their individual characteristics and this fact should be borne in mind if replacement of the H.F. oscillator tube becomes necessary. A check of the dial calibration should be made if this tube is replaced to determine whether or not realignment is necessary.

Bypass or filter capacitors which become open may cause decreased sensitivity, oscillation, poor stability or complete failure of the Receiver. The defective unit can be located by temporarily connecting a good capacitor in parallel with each suspected capacitor. Leaky or short-circuited capacitors can be detected by an ohmmeter check; a zero resistance reading

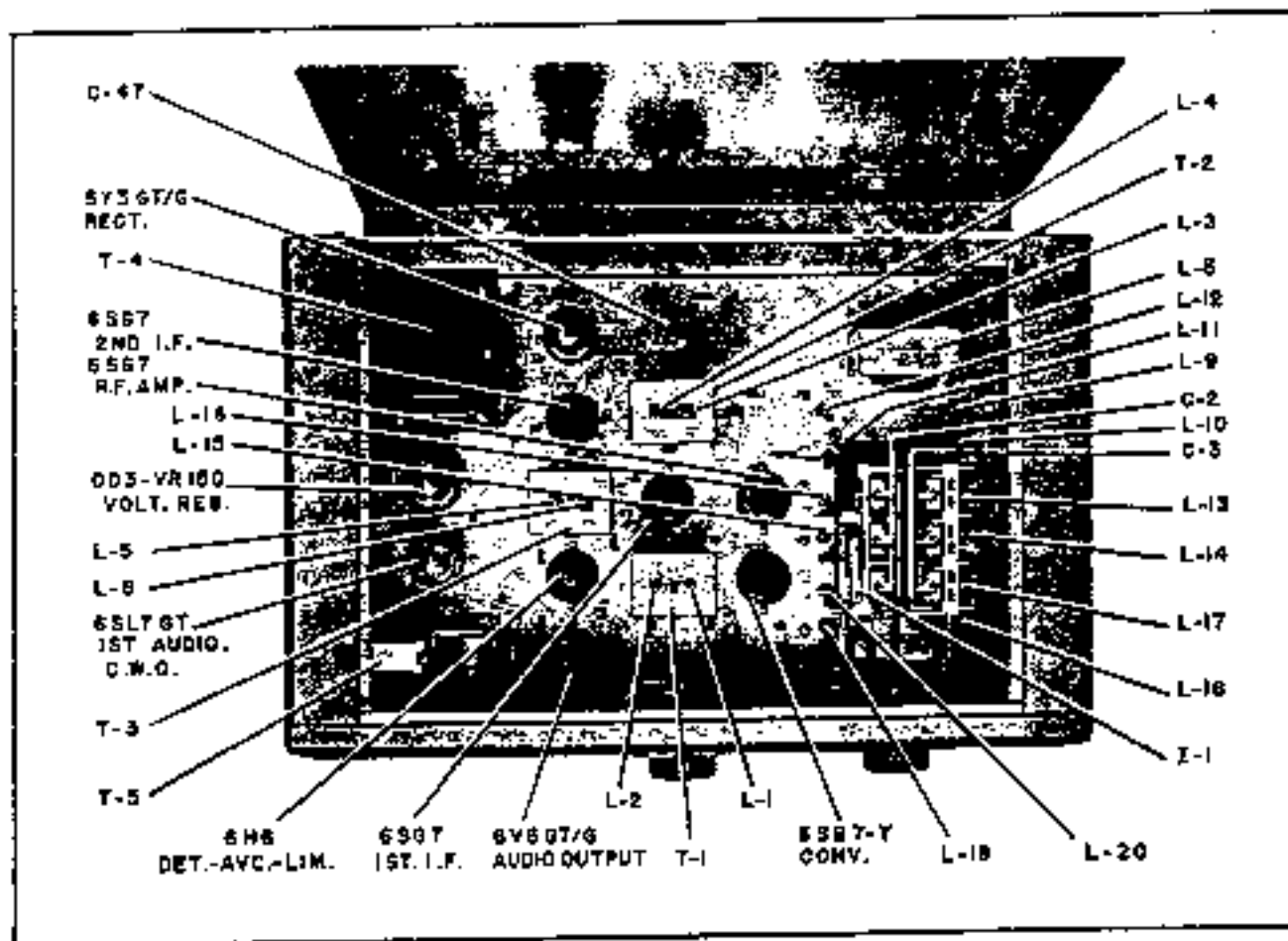

Figure No. 3. Top View of Receiver

of the ohmmeter will indicate a shorted capacitor.

Defective resistors, sometimes caused by capacitor failure in associated circuits, can be definitely located by measuring the resistance of each resistor. The Schematic Diagram should be consulted to ascertain that any particular resistor under test is not connected in parallel with some other circuit element which might produce a false measurement. An overloaded resistor may be located by visual inspection if the surface of the resistor becomes scorched due to excessive heating.

4-2. Voltage Tabulation

The measurements of voltage shown on the following table are tabulated using a high-impedance vacuum tube voltmeter with a line voltage of 115 volts. The control settings to be observed are as follows:

1. R.F. GAIN full on. (extreme clockwise position)
2. BAND switch at E.
3. Main tuning dial pointer at 1.5 mc.
4. Control switch at M.V.C. except as noted.

All voltages are measured between specified terminal and chassis.

TUBE TERMINAL	PIN	VOLTS ± 15%
R. F. Amp. Cathode	3&5	2.3
R. F. Amp. Screen	6	130
R. F. Amp. Plate	8	210
H. F. Osc. Plate	3	250
First Det. Grid	4	100
H. F. Osc. Grid	5	-19
First I. F. Amp. Cathode	3&5	1.6
First I. F. Amp. Screen	6	60
First I. F. Amp. Plate	8	250
Second I. F. Amp. Cathode	3&5	2.4
Second I. F. Amp. Screen	6	130
Second I. F. Amp. Plate	8	250
Limiter Plate	3	-.2*
Limiter Cathode	4	-.2*
Second Detector Plate	5	-.3
First Audio Plate	2	90
First Audio Cathode	3	1.2
C. W. Oscillator Grid	4	-2.8**
C. W. Oscillator Plate	5	120**
Audio Output Plate	3	230
Audio Output Screen	4	250
Audio Output Cathode	8	13
Rectifier Fil.	2	270
Rectifier Plate	4	300 A.C.
Rectifier Plate	6	300 A.C.
Rectifier Fil.	8	270
Voltage Regulator Anode	5	150

* Control Switch at A.N.L.
 ** Control Switch at C.W.O.

SECTION 5. ALIGNMENT DATA

5-1. General

The alignment of the NC-57 may be divided into two steps:

1. Intermediate Frequency Amplifier Alignment.
2. General Coverage Alignment
 - a. H. F. Oscillator
 - b. First Detector and R. F. Amplifier.

The necessity for any realignment may be determined by checking the performance of the Receiver against its normal operation, as outlined in Section 3, and the dial calibration. It is recommended that, if tests indicate realignment is required, the instructions given in this section are thoroughly read and understood before realignment is attempted. For alignment purposes the Receiver should be set up as

specified in Section 2-1 except that the antenna should be disconnected. An output meter with a resistive load of 8 ohms should be connected to the Phones jack on the front panel of the Receiver.

5-2. I. F. Amplifier Alignment

The intermediate frequency of the NC-57 Receiver is 455 kilocycles. The two I. F. transformers and the detector input transformer have permeability tuned iron-core inductors with screw adjustments for alignment purposes. These adjustments are accessible from the top inside of the cabinet as shown on Figure No. 3.

The alignment procedure is as follows:

1. Connect the "high" output lead of an accurately calibrated signal generator to the stator of the detector portion of the main tuning capacitor, C-2E,

and the grounded lead to any convenient grounded point on the chassis. This is a direct connection, no dummy antenna being required. Set the signal generator at 455 kilocycles and turn the modulation on.

2. Set the control switch at M.V.C.
3. Set the R.F. GAIN control full on.
4. Set the TONE switch at High.
5. Set the A.F. GAIN full on.
6. Adjust the output attenuator of the signal generator to provide a signal of approximately 100 microvolts. While making I.F. amplifier adjustments, it will be necessary to retard the attenuator of the signal generator if I.F. amplifier gain increases to a point where overload occurs.

7. Adjust the I.F. tuned inductors L-1 through L-6 for maximum gain, as indicated on the output meter. The order in which these adjustments are made is not important.

At the conclusion of the I.F. amplifier alignment the tuning of the C.W. oscillator may be checked by turning the modulation of the signal generator off and setting the control switch at C.W.O. With this setting zero beat with the test signal should occur with the PITCH control set at mid-scale. If the above test indicates realignment of the C.W. oscillator is required proceed as follows:

1. Remove the bottom cover of the Receiver.
2. Loosen the set screw on the collar of the C.W. oscillator transformer shaft.
3. Without loosening the PITCH control knob on its shaft withdraw the knob and shaft from the cabinet.
4. The screw driver adjustment on the C.W. oscillator inductor, L-7, will then be accessible through the shaft opening in the cabinet. Adjust L-7 for zero beat with the test signal.
5. Replace the PITCH control knob and shaft so that the white dot on the knob is at mid-scale.
6. Position the collar so that the set screw is directly opposite (180°) from

the stop and tighten the set screw making sure that the position of the PITCH control knob does not change from mid-scale.

5.3. General Coverage Alignment

General coverage alignment and bandspread alignment are accomplished simultaneously, since the main tuning and bandspread tuning capacitors are connected in parallel on all bands. The Receiver should be set up as specified in Section 2-1 except that the antenna should be disconnected. Adjustment of the H.F. oscillator and first detector trimmers can be made through the holes in the bottom cover of the Receiver after removal of the small cover plate. See Figure No. 5. All inductor adjustments are accessible from the top inside of the cabinet. The preliminary alignment procedure is as follows:

1. Connect an accurate signal source (signal generator or crystal oscillator) to the antenna input terminals through a standard dummy antenna of 300 ohms.
2. Connect an output meter with a resistive load of 8 ohms to the Phones jack.
3. Set the control switch at M.V.C.
4. Turn the R.F. GAIN control to full on.
5. Set the bandspread and main tuning dials as shown on the Alignment Table.

The Alignment Table in this section outlines the procedure for alignment of the H.F. oscillator, first detector and R.F. amplifier stages.

(a) H.F. Oscillator

Care should be taken when aligning the H.F. oscillator of any band to insure that the oscillator is aligned to the fundamental frequency and not the image. This can be checked by tuning the Receiver to the image frequency. On the A and B bands the image should appear 910 kilocycles above the fundamental signal. On the C, D and E bands the image should appear 910 kilocycles below the fundamental signal. If the image does not appear at its correct setting the H. F. oscillator trimmer should be adjusted for the correct calibration.

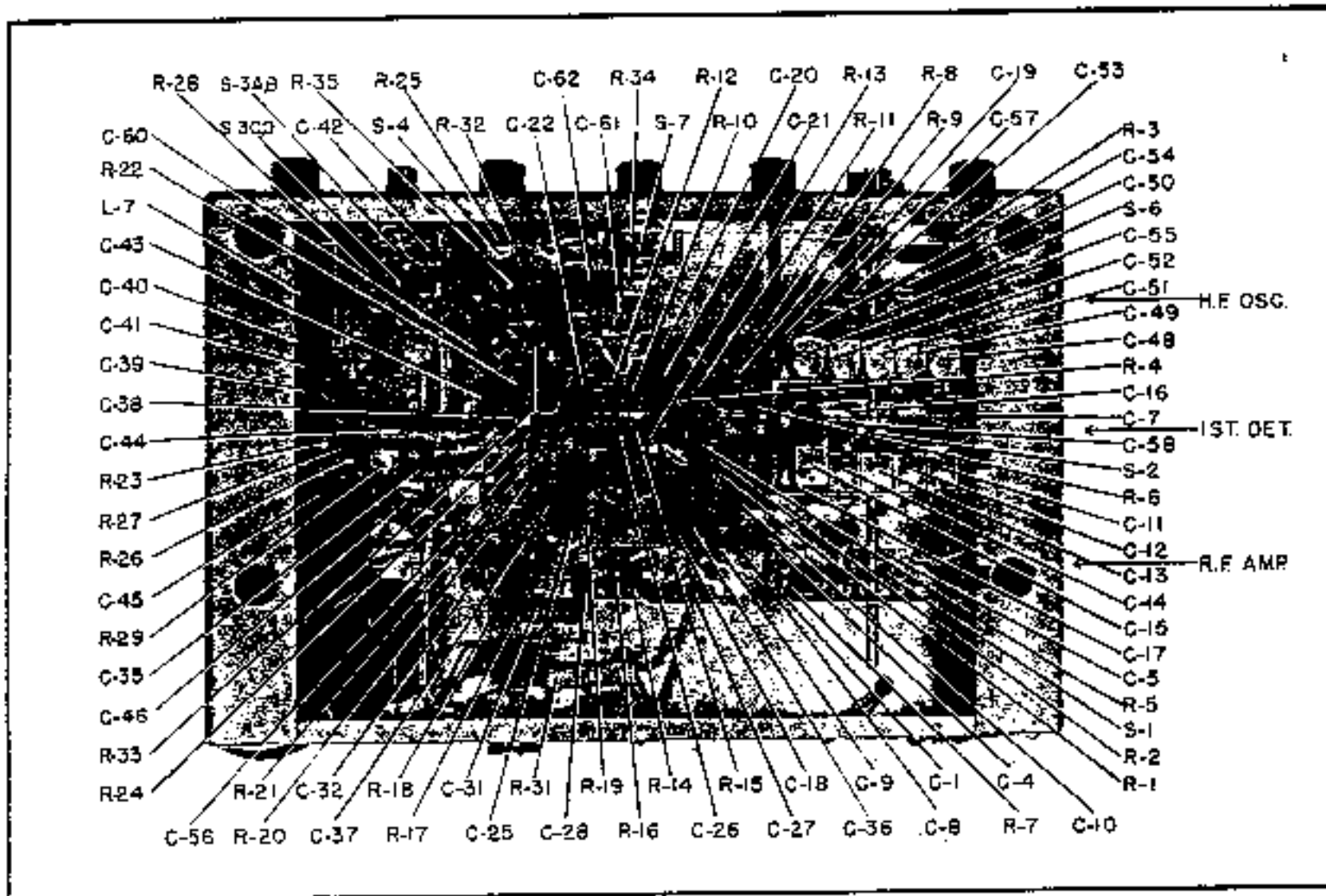

Figure No. 4. Bottom View of Receiver

Step	Band	Adjust Signal Source To:	Sec. Main Tun. Dial No.:	Set Bandspread Dial No.:	Adjust To Receive First Signa.	Adjust For Maximum Output
1	A	54.0 Mc.	54.0 Mc.	Sec	C-48	C-11, C-4
1	B	34.0 Mc.	34.0 Mc.	Set	C-49	C-12, C-4
2	B	12.0 Mc.	12.0 Mc.	Sec	L-17	C-11, L-9
3	B	34.0 Mc.	34.0 Mc.	Set		Check Step 1. Repeat Steps 1, 2 and 3 if necessary.
1	C	12.0 Mc.	12.0 Mc.	Set	C-31	C-11, C-4
2	C	4.4 Mc.	4.4 Mc.	Sec	L-13	L-14, L-10
3	C	12.0 Mc.	12.0 Mc.	Set		Check Step 1. Repeat Steps 1, 2 and 3 if necessary.
1	D	4.4 Mc.	4.4 Mc.	Set	C-52	C-14, C-4
2	D	1.5 Mc.	1.5 Mc.	Sec	L-19	L-15, L-11
3	D	1.5 Mc.	Take Signal	Zero		L-15, L-11
4	D	4.4 Mc.	4.4 Mc.	Set		Check Step 1. Repeat Steps 1, 2, 3 and 4 if necessary.
1	E	0.6 Mc.	0.6 Mc.	Zero	L-20	L-14, L-12
2	E	1.5 Mc.	1.5 Mc.	Sec	C-55	C-15, C-4
3	E	0.6 Mc.	0.6 Mc.	Set		Check calibration. Repeat Steps 1, 2 and 3 if necessary.

ALIGNMENT TABLE

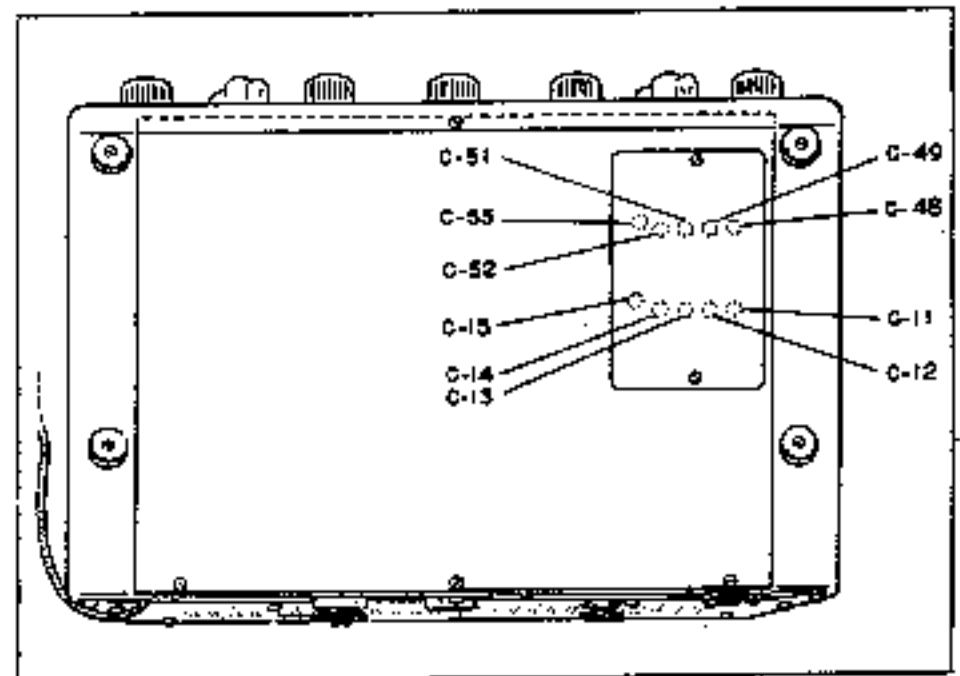

Figure No. 5. Alignment Trimmer Locations

SECTION 6. SM-57 TUNING METER

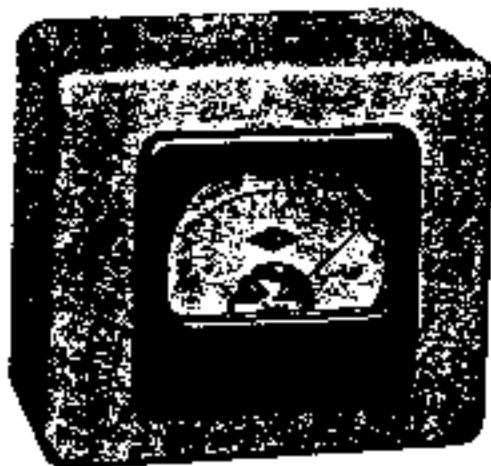

Figure No. 6. SM-57 Tuning Meter

6-1. General

The SM-57 Tuning Meter is available as an accessory for use with the NC-57 as a tuning indicator and relative signal strength indicator. The SM-57 is fitted with a cable and plug for connection to the Accessory Connector Socket at the rear of the NC-57 and is contained in a metal case finished to match the Receiver.

To utilize the SM-57 the following receiver control settings must be observed:

1. Control switch at A.V.C. or A.N.L.
2. R.F. GAIN control full on. (Retarding the R.F. GAIN control will reduce the sensitivity of the meter.)

The correct dial setting for any specific station on the dial is that setting which provides maximum deflection of the meter

pointer.

6-2. Meter Adjustment

Two adjustments are provided on the SM-57; one mechanical and the other electrical.

1. Mechanical -- With the Receiver turned off, the meter pointer should read 40 db. (the last scale marking). If it does not, correction is effected by the screw adjustment on the front of the meter.

2. Electrical -- With the Receiver turned on and controls adjusted for meter operation, the meter pointer should read zero (the first scale marking). This test must be made with no signal input to the Receiver. Correction of the zero setting, if required, is made by means of the screwdriver adjustment (R-101) at the rear of the meter case.

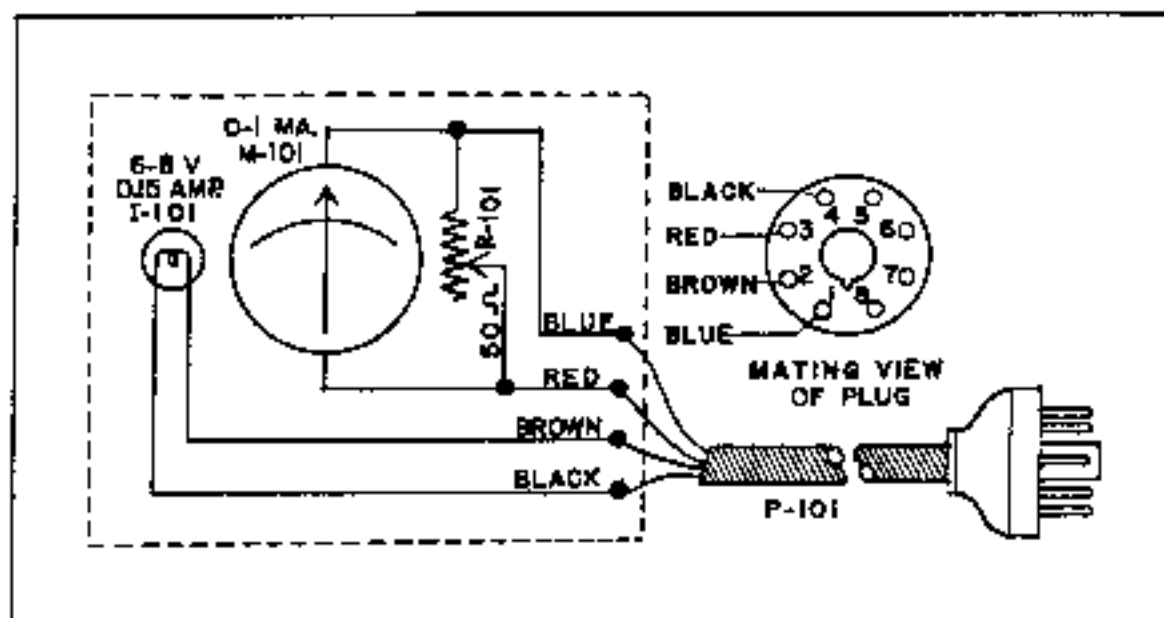

Figure No. 7. Schematic Diagram--SM-57 Tuning Meter

PARTS LIST

SECTION 7.

Symbol	Function	Rating	Symbol	Function	Rating
Capacitors			Capacitors (Contd.)		
C-1	E Band R.F. Amp. Filter	Paper, 0.01 mfd, 300 vdcw	C-44	1st. Audio Cathode Bypass	Elect., 10 mfd, 50 vdcw
C-2	Bandspread Tuning	Air, Variable	C-45	A.C. Line Bypass	Paper, 0.01 mfd, 600 vdcw
C-2A	R.F. Bandspread Tuning	Air, Part of C-2	C-46	B Supply Filter	Paper, 0.01 mfd, 400 vdcw
C-2B	1st. Det. Bandspread Tun.	Air, Part of C-2	C-47	Power Supply Filter	Elect. 10+10 mfd, 450 vdcw
C-2C	H.F. Osc. Bandspread Tun.	Air, Part of C-2	C-47A	Power Supply Filter	Part of C-47
C-3	Main Tuning	Air, Variable	C-47B	Power Supply Filter	Part of C-47
C-3A	R.F. Tuning	Air, Part of C-3	C-48	A Band H.F. Osc. Trimmer	Ceramic, Variable
C-3B	1st. Det. Tuning	Air, Part of C-3	C-49	B Band H.F. Osc. Trimmer	Ceramic, Variable
C-3C	H.F. Osc. Tuning	Air, Part of C-3	C-50	C Band H.F. Osc. Padder	Mica, .0043 mfd, 500 vdcw
C-4	Trimmer Control	Air, Variable	C-51	C Band H.F. Osc. Trimmer	Ceramic, Variable
C-5	A Band R.F. Amp. Padder	Mica, 100 mmf, 500 vdcw	C-52	D Band H.F. Osc. Trimmer	Ceramic, Variable
C-6	Not Used		C-53	D Band H.F. Osc. Padder	Mica, 0.0013 mfd, 500 vdcw
C-7	B Band 1st. Det. Coupling	Ceramic, 5 mmf, 500 vdcw	C-54	E Band H.F. Osc. Padder	Mica, 510 mmf, 500 vdcw
C-8	R.F. Amp. Grid Coupling	Mica, 100 mmf, 500 vdcw	C-55	E Band H.F. Osc. Trimmer	Ceramic, Variable
C-9	R.F. Amp. Cathode Bypass	Paper, 0.01 mfd, 400 vdcw	C-56	Audio Coupling	Paper, 0.01 mfd, 400 vdcw
C-10	R.F. Amp. Screen Bypass	Paper, 0.01 mfd, 600 vdcw	C-57	A Band H.F. Osc. Padder	Mica, 100 mmf, 500 vdcw
C-11	A Band 1st. Det. Trimmer	Mica, Variable	C-58	C Band 1st. Det. Coupling	Ceramic, 5 mmf, 500 vdcw
C-12	B Band 1st. Det. Trimmer	Mica, Variable	C-59	Not Used	
C-13	C Band 1st. Det. Trimmer	Mica, Variable	C-60	Audio Coupling	Paper, 0.001 mfd, 600 vdcw
C-14	D Band 1st. Det. Trimmer	Mica, Variable	C-61	Audio Output Cathode Bypass	Elect. 25 mfd, 50 vdcw
C-15	E Band 1st. Det. Trimmer	Mica, Variable	C-62	Tone	Paper, 0.1 mfd, 400 vdcw
C-16	A Band 1st. Det. Padder	Mica, 100 mmf, 500 vdcw	Resistors		
C-17	R.F. Amp. Plate Filter	Mica, 0.001 mfd, 300 vdcw	R-1	R.F. Amp. Grid Filter	Fixed, 150,000 ohms 1/2 W
C-18	Cathode Bus Filter	Paper, 0.1 mfd, 400 vdcw	R-2	R.F. Amp. Cathode	Fixed, 220 ohms 1/2 W
C-19	H.F. Osc. Grid Coupling	Mica, 100 mmf, 500 vdcw	R-3	R.F. Gain Control	Var. 10,000 ohms 2 W
C-20	1st. Det. Screen Bypass	Paper, 0.01 mfd, 400 vdcw	R-4	B Plus Bleeder	Fixed, 68,000 ohms 2 W
C-21	1st. Det. Plate Filter	Paper, 0.01 mfd, 600 vdcw	R-5	R.F. Amp. Screen Filter	Fixed, 1,000 ohms 1/2 W
C-22	1st. I.F. Amp. Grid Fil.	Paper, 0.01 mfd, 400 vdcw	R-6	R.F. Amp. Plate Filter	Fixed, 4,700 ohms 1/2 W
C-23	T-1 Pri. Tuning	Mica, 510 mmf, 500 vdcw	R-7	A.V.C. Bleeder	Fixed, 100,000 ohms 1/2 W
C-24	T-1 Sec. Tuning	Mica, 510 mmf, 500 vdcw	R-8	H.F. Osc. Grid	Fixed, 33 ohms 1/2 W
C-25	1st. I.F. Amp. Cathode Bypass	Paper, 0.1 mfd, 400 vdcw	R-9	H.F. Osc. Grid Leak	Fixed, 47,000 ohms 1/2 W
C-26	1st. I.F. Amp. Screen Bypass	Paper, 0.01 mfd, 600 vdcw	R-10	1st. Det. Plate Filter	Fixed, 1,000 ohms 1/2 W
C-27	1st. I.F. Amp. Plate Fil.	Paper, 0.01 mfd, 600 vdcw	R-11	1st. Det. Screen Filter	Fixed, 3,900 ohms 1/2 W
C-28	2nd. I.F. Grid Filter	Paper, 0.01 mfd, 400 vdcw	R-12	1st. I.F. Amp. Grid Fil.	Fixed, 470,000 ohms 1/2 W
C-29	T-2 Pri. Tuning	Mica, 510 mmf, 500 vdcw	R-13	1st. I.F. Amp. Cathode	Fixed, 330/1000 ohms 1/2 W
C-30	T-2 Sec. Tuning	Mica, 510 mmf, 500 vdcw	R-14	1st. I.F. Amp. Plate Fil.	Fixed, 1,000 ohms 1/2 W
C-31	2nd. I.F. Amp. Cathode Bypass	Paper, 0.1 mfd, 400 vdcw	R-15	1st. I.F. Amp. Screen Filter	Fixed, 470,000 ohms 1/2 W
C-32	2nd. I.F. Amp. Screen Bypass	Paper, 0.01 mfd, 400 vdcw	R-16	2nd. I.F. Grid Filter	Fixed, 470,000 ohms 1/2 W
C-33	T-3 Pri. Tuning	Mica, 510 mmf, 500 vdcw	R-17	2nd. I.F. Amp. Cathode	Fixed, 220 ohms 1/2 W
C-34	T-3 Sec. Tuning	Mica, 510 mmf, 500 vdcw	R-18	2nd. I.F. Amp. Screen Filter	Fixed, 2,200 ohms 1/2 W
C-35	Limiter Cathode Filter	Paper, 0.1 mfd, 400 vdcw	R-19	A.V.C. Filter	Fixed, 220,000 ohms 1/2 W
C-36	A.V.C. Filter	Paper, 0.01 mfd, 400 vdcw	R-20	Limiter Filter	Fixed, 100,000 ohms 1/2 W
C-37	2nd. Det. Load	Mica, 100 mmf, 500 vdcw	R-21	2nd. Det. Load	Fixed, 100,000 ohms 1/2 W
C-38	C.W.O. Coupling	3 Turns Insulated Wire	R-22	2nd. Det. Load	Fixed, 220,000 ohms 1/2 W
C-39	C.W.O. Plate Coupling	Paper, 0.01 mfd, 600 vdcw	R-23	C.W.O. Plate Filter	Fixed, 10,000 ohms 1/2 W
C-40	C.W.O. Tuning	Mica, 220 mmf, 500 vdcw	R-24	Limiter Cathode	Fixed, 100,000 ohms 1/2 W
C-41	C.W.O. Grid Coupling	Mica, 270 mmf, 500 vdcw	R-25	Audio Gain Control	Variable, 500,000 ohms
C-42	Audio Coupling	Paper, 0.01 mfd, 600 vdcw	R-26	1st. Audio Cathode	Fixed, 2,700 ohms 1/2 W
C-43	1st. Audio Plate Filter	Paper, 250 mmf, 600 vdcw	R-27	C.W.O. Grid	Fixed, 22,000 ohms 1/2 W

Figure No. 9. Schematic Diagram NC-57 Receiver

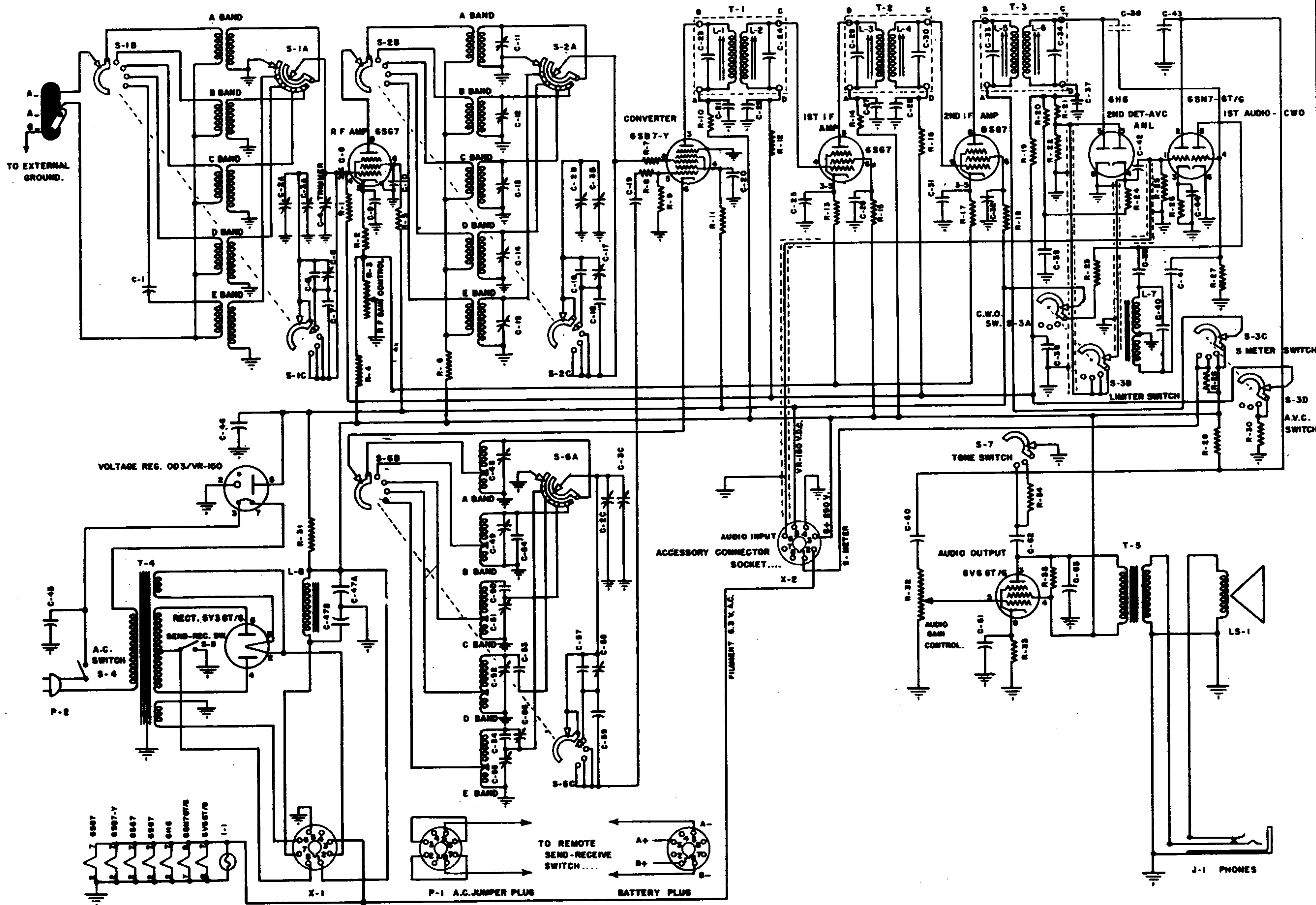

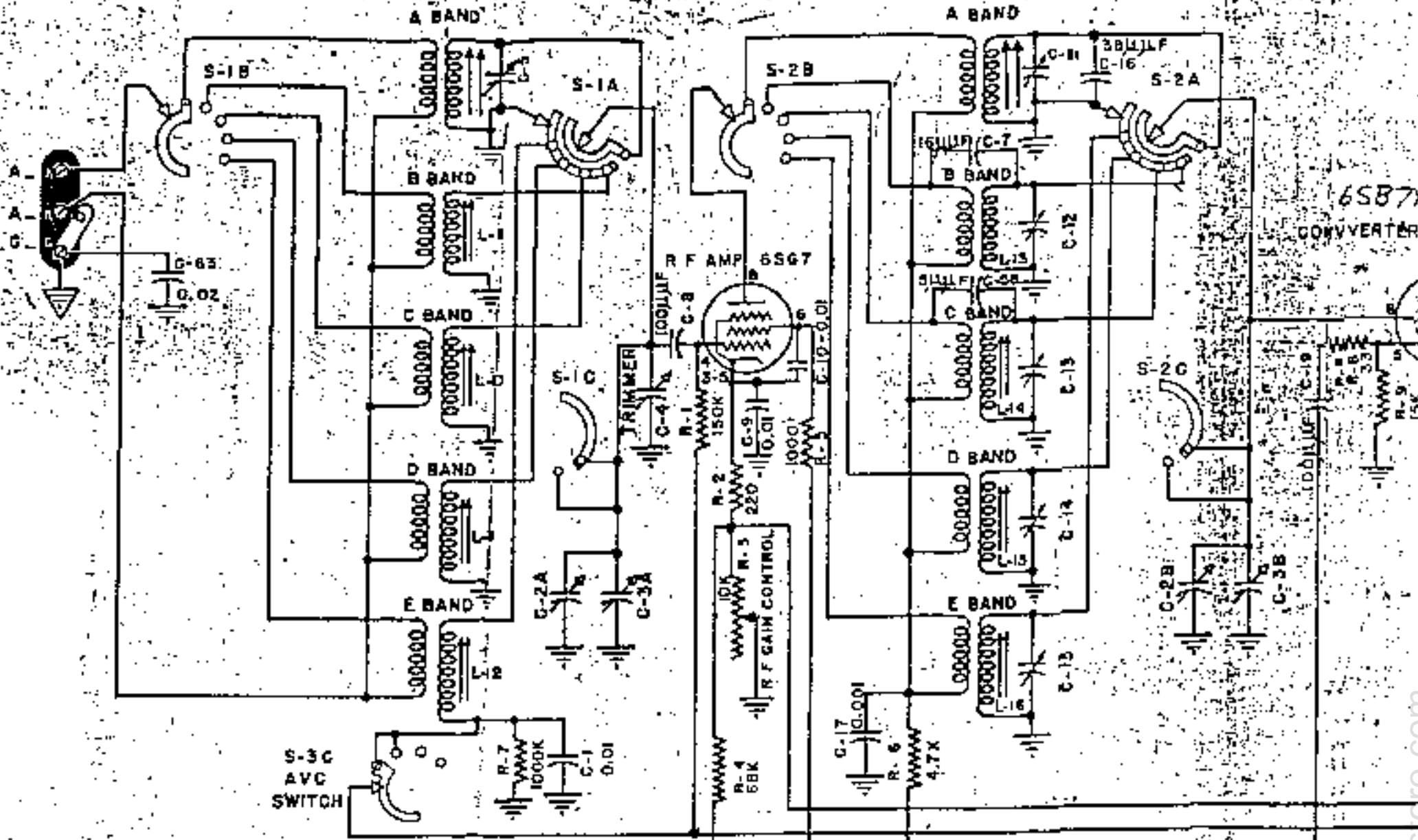

BAND SWITCHES SHOWN IN A BAND POSITION

VOLTAGE REG. 0A3/YR75

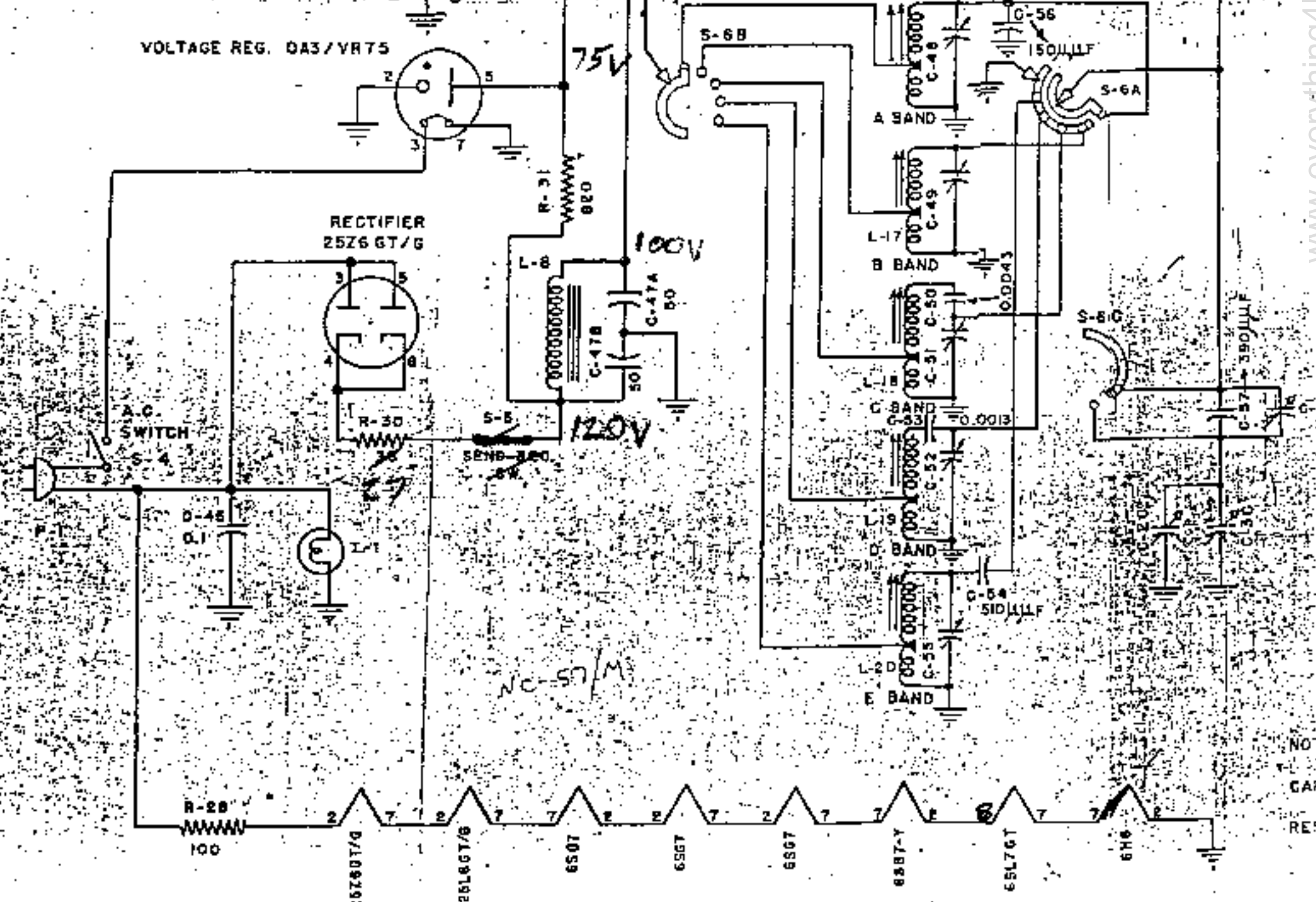

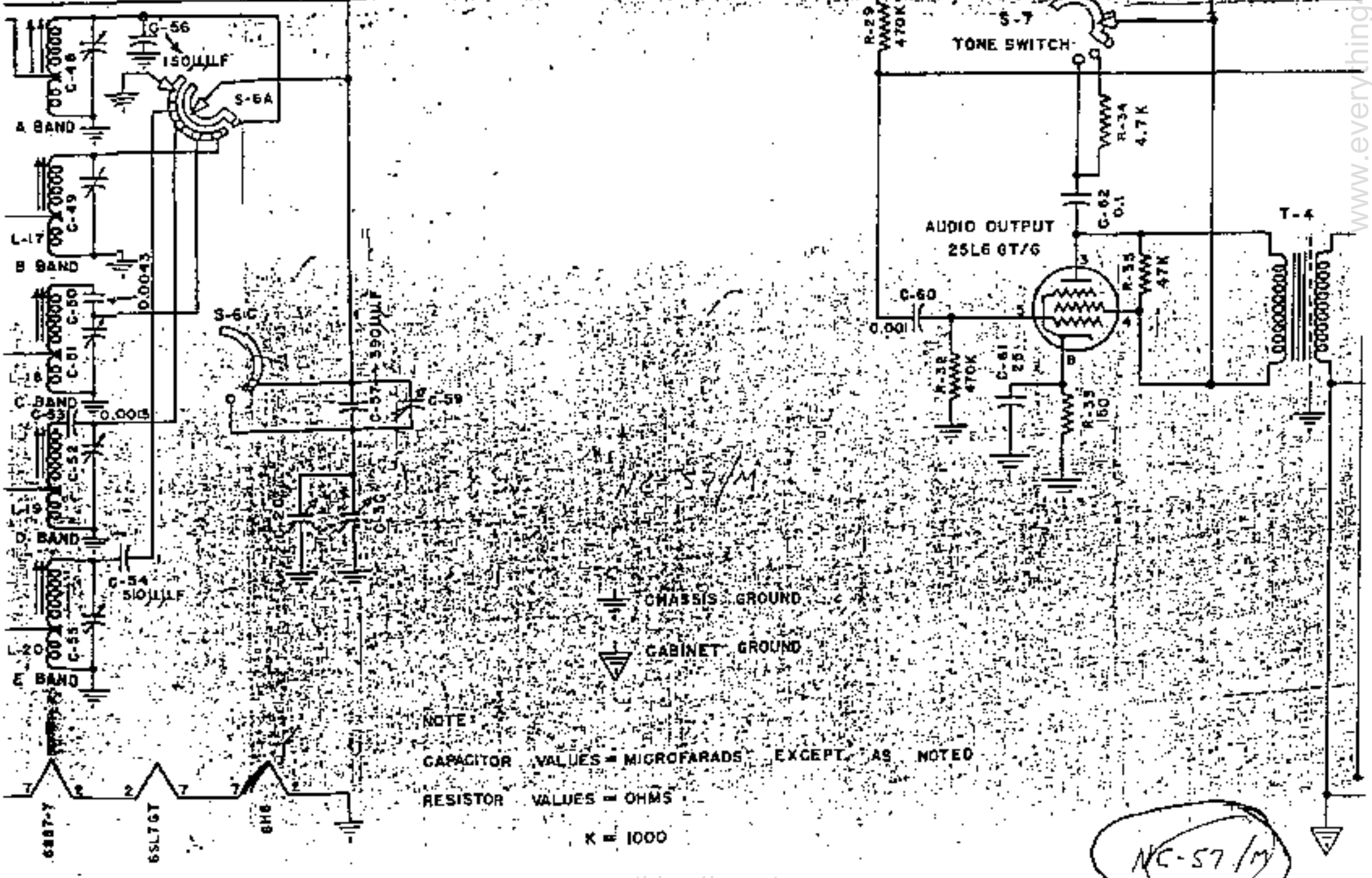
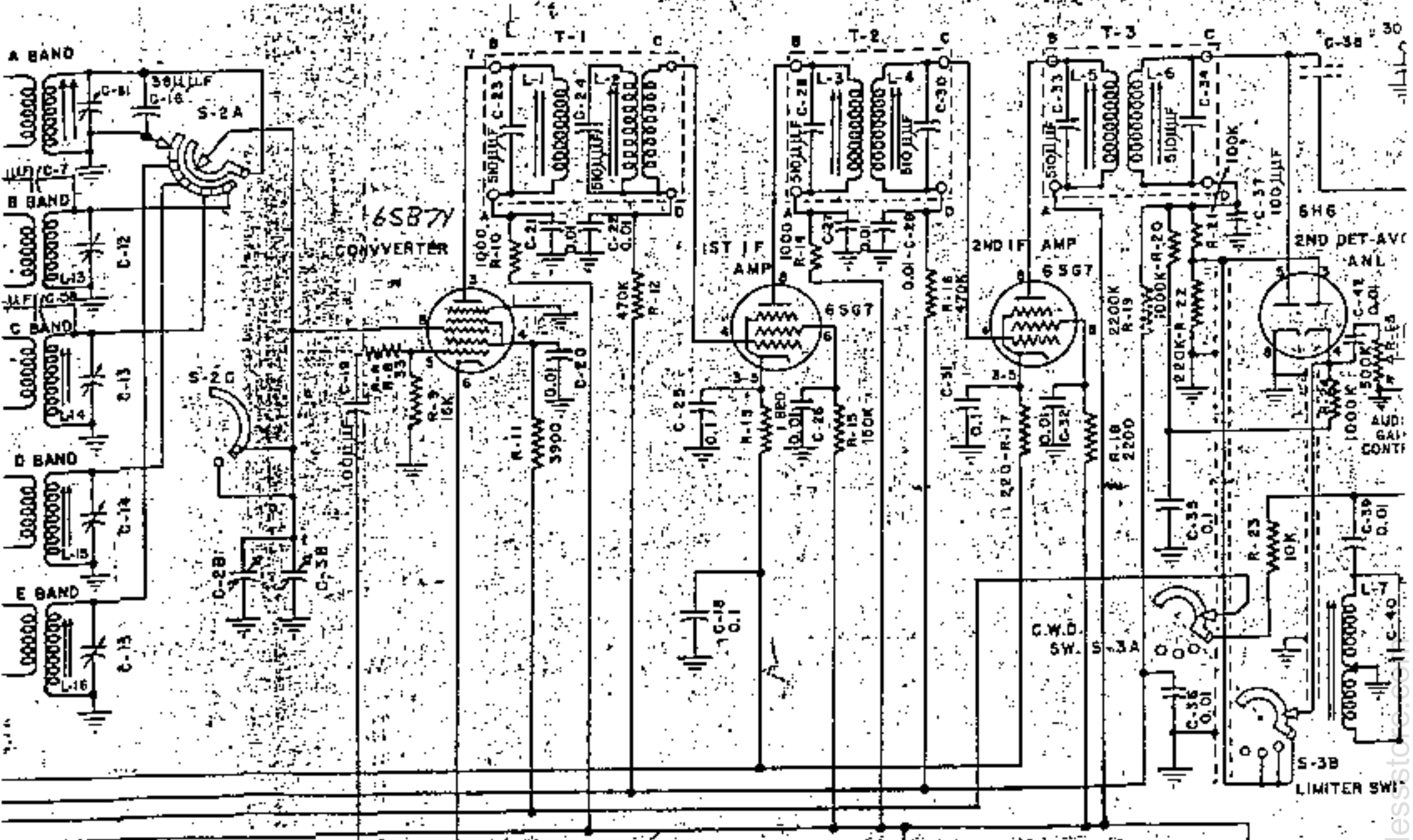

NOTE:
 CAPACITOR VALUES = MICROFARADS EXCEPT AS NOTED
 RESISTOR VALUES = OHMS
 K = 1000

NC-57/M

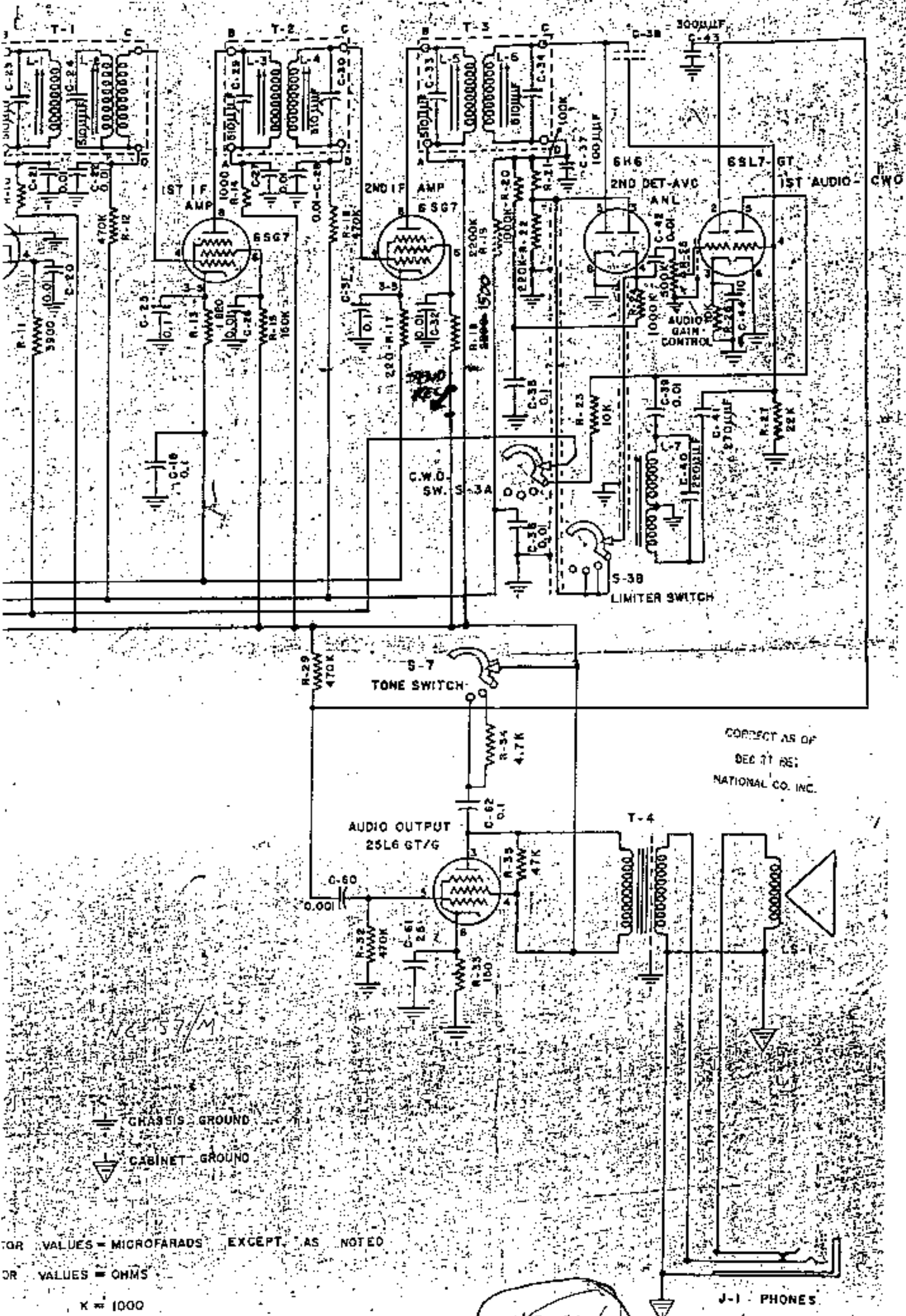

FOR VALUES = MICROFARADS EXCEPT AS NOTED
 OR VALUES = OHMS
 X = 1000

NC-57/M

CORRECT AS OF
 DEC 31 1951
 NATIONAL CO. INC.