

6AJ8

6N8

6GW8

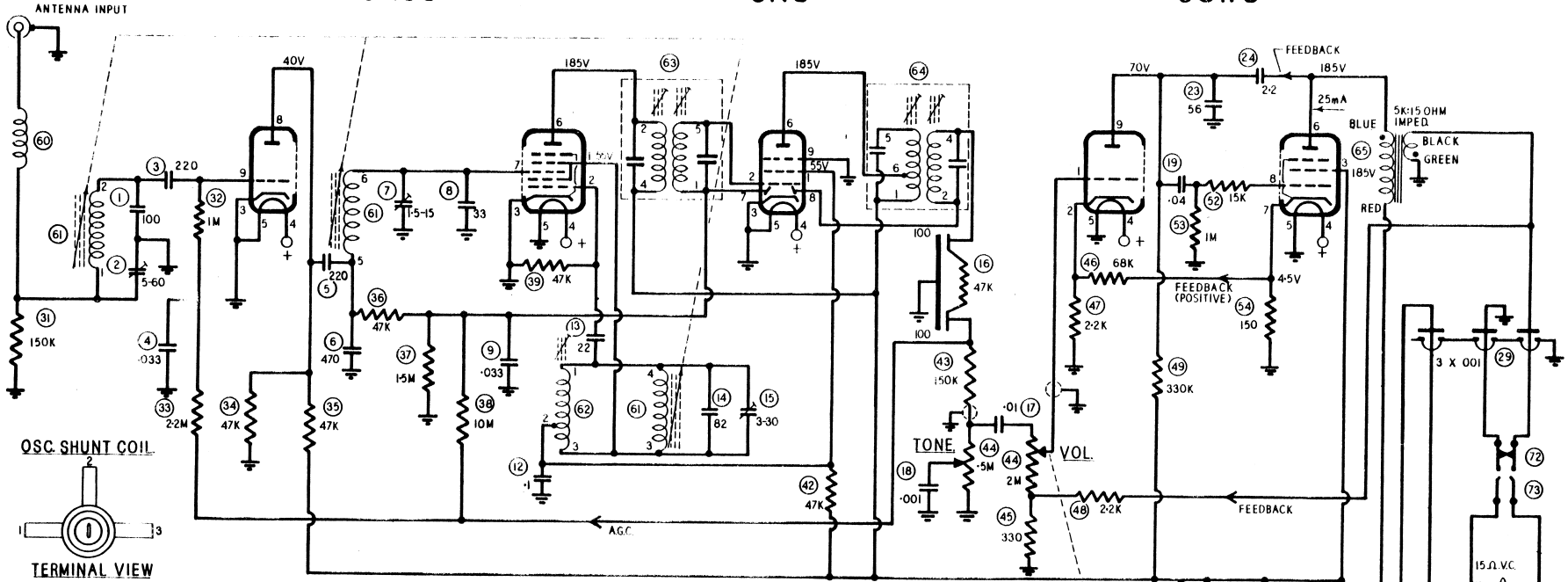

OSC. SHUNT COIL

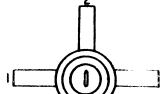

TERMINAL VIEW

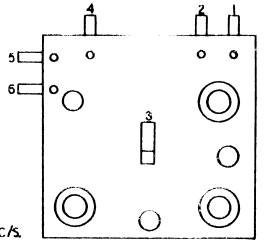

I.F. - 455Kc/s

PERMEABILITY TUNER UNIT  
REAR VIEW

ALL VOLTAGES MEASURED BETWEEN POINTS INDICATED AND CHASSIS WITH A D.C. VACUUM-TUBE VOLTMETER, NO INPUT SIGNAL.

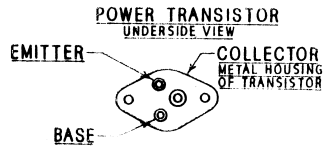

NUMBERS ASSIGNED TO TERMINALS OF COILS AND TRANSFORMERS ARE TO FACILITATE CIRCUIT TRACING OR COMPONENT REPLACEMENT AND MAY NOT BE FOUND ON THE UNIT.

1st I.F. TRANS.

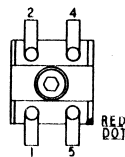

2nd I.F. TRANS.

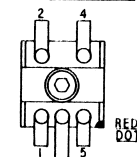

MODEL JQV  
NEGATIVE TO CHASSIS

MANUAL TUNING

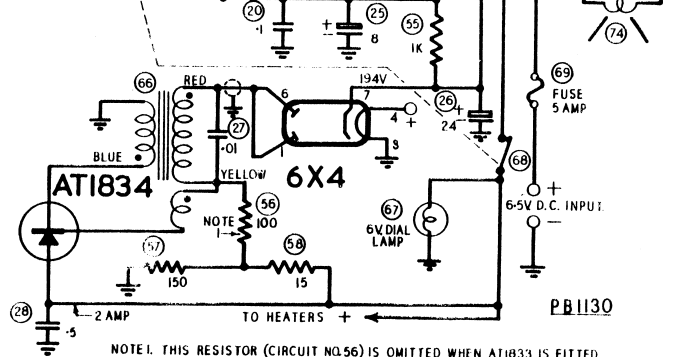

NOTE: THIS RESISTOR (CIRCUIT NO.56) IS OMITTED WHEN AT1833 IS FITTED.