

N4.

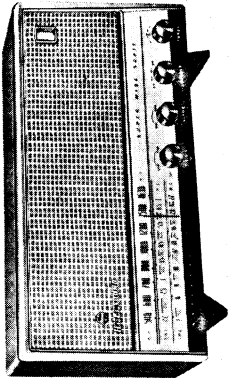

MODEL DE-631

SCHEMATIC DIAGRAM & TUBE CONNECTION

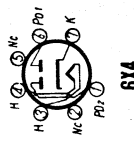
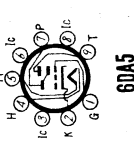
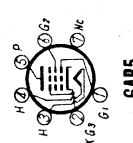
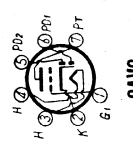
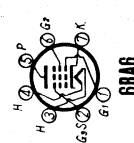
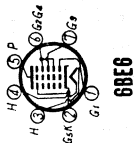
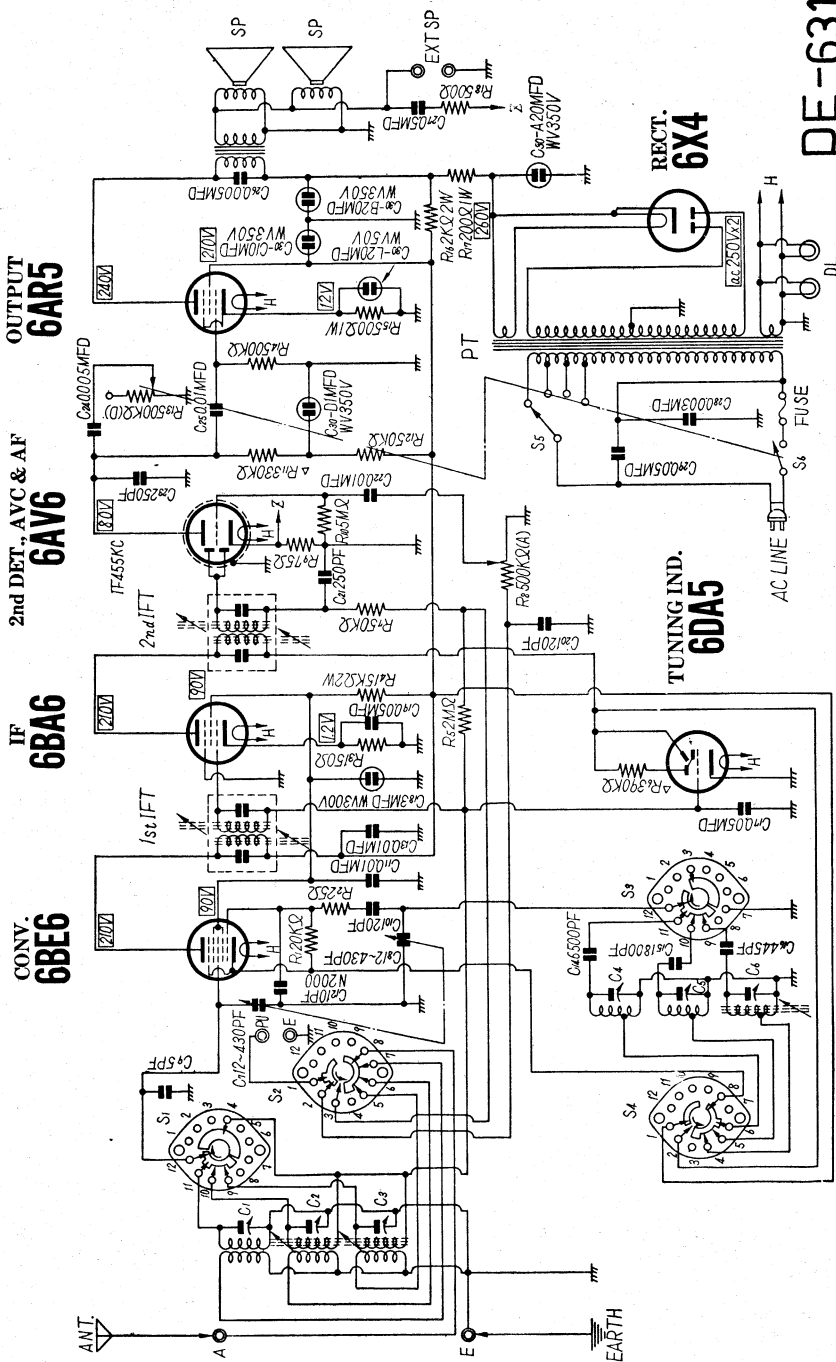

△ MARKS: Solid resistor

DE-631

(BOTTOM VIEW)