

**Supplement**

<OLD>

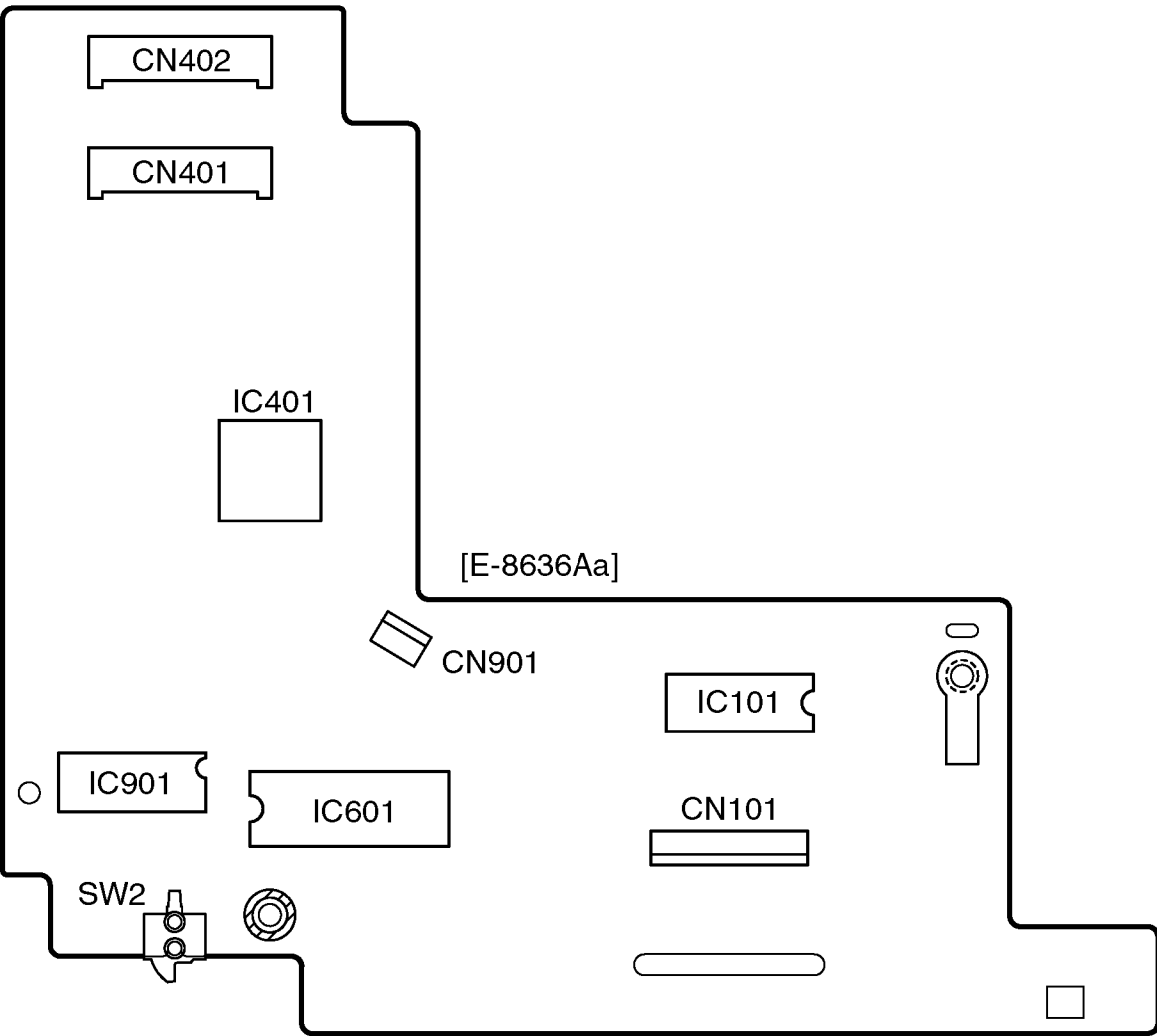

5 ICs are mounted on servo circuit.

<NEW>

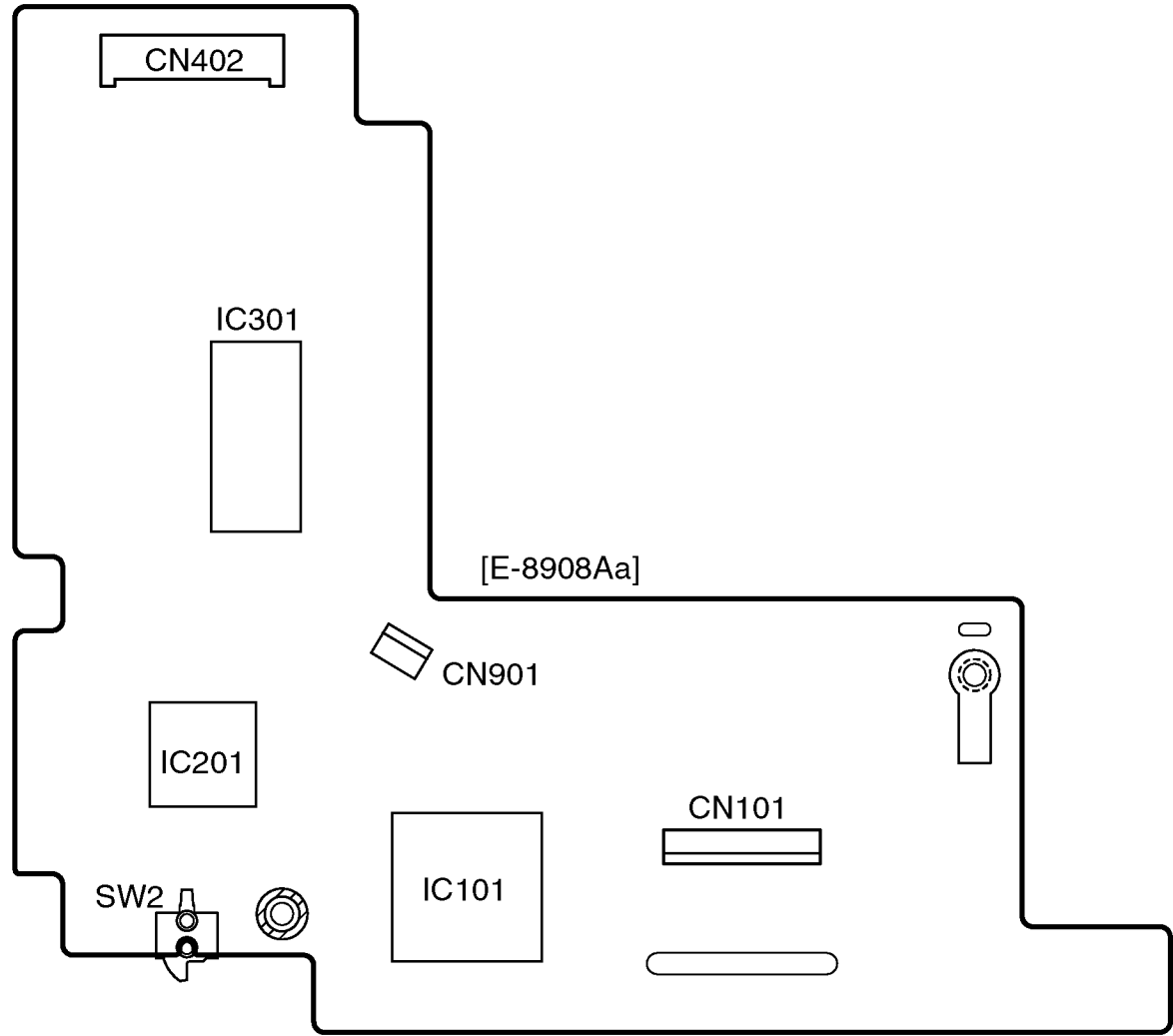

3 ICs are mounted on servo circuit.

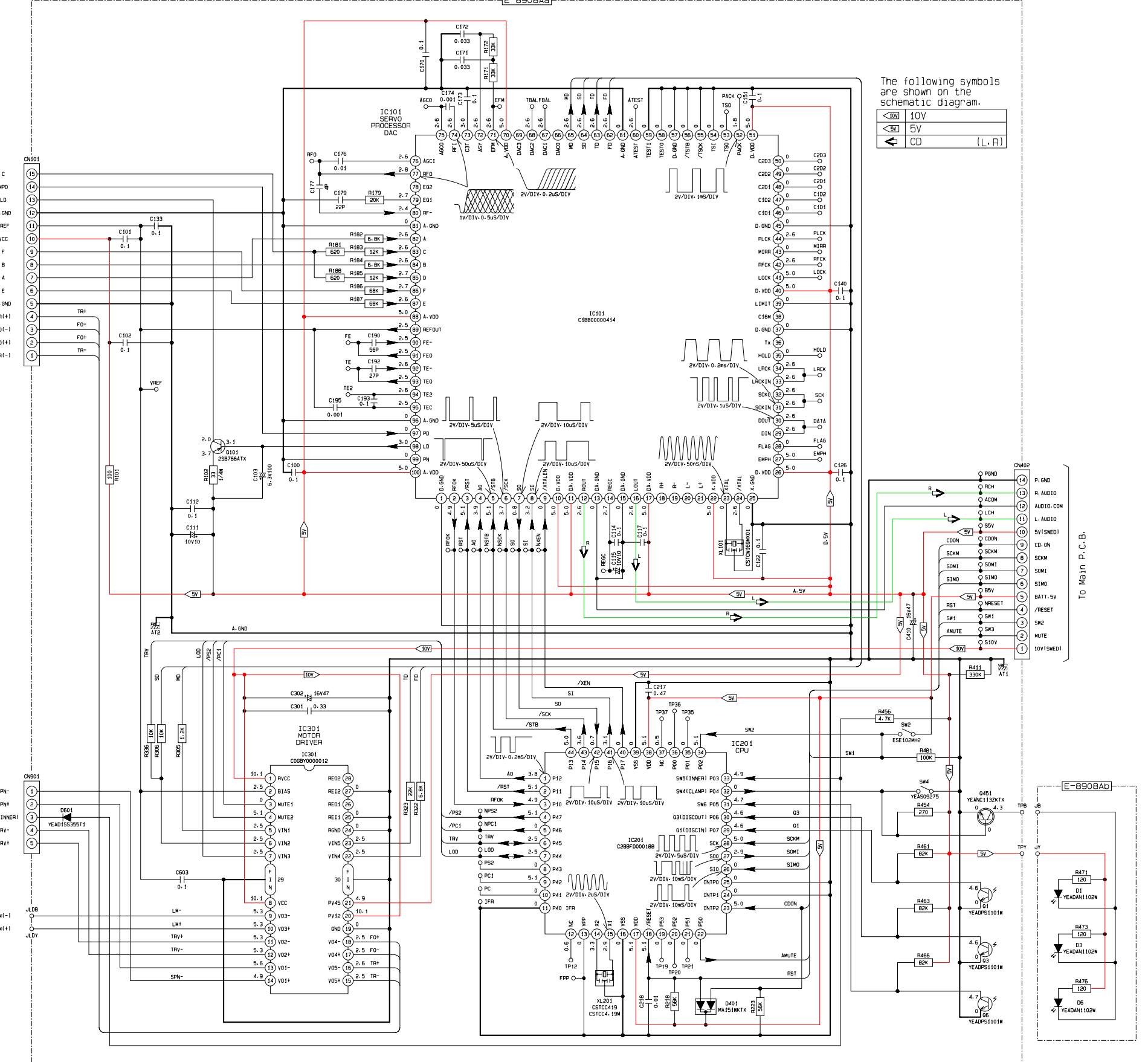
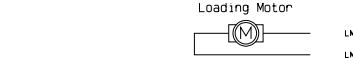
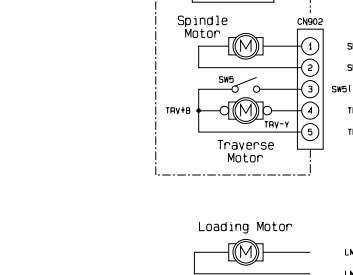
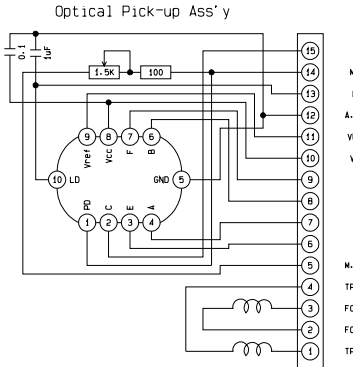

The following symbols are shown on the schematic diagram.

To Main P.C.B.

<BOTTOM VIEW>

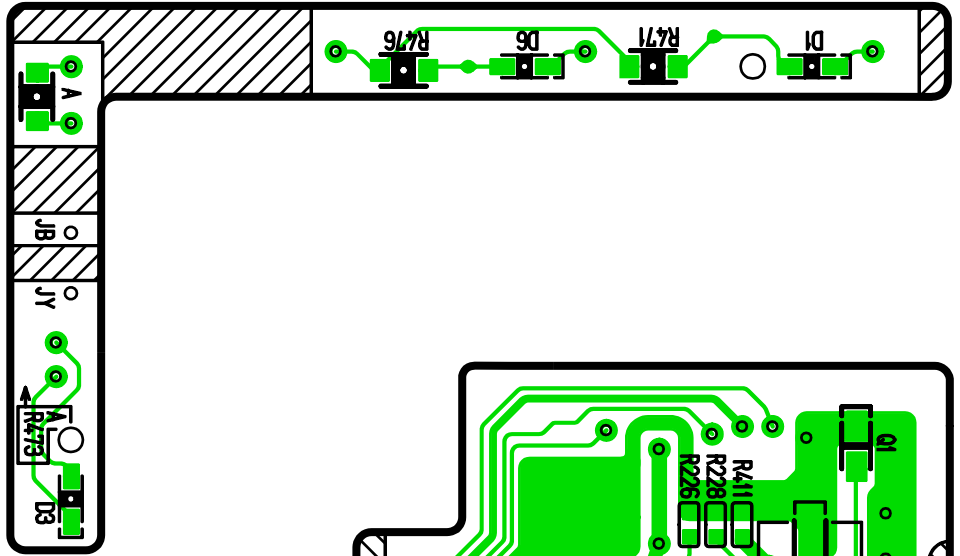

<BOTTOM VIEW>

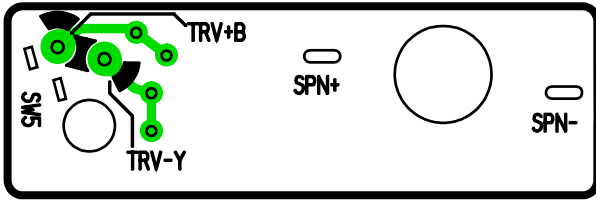

<BOTTOM VIEW>

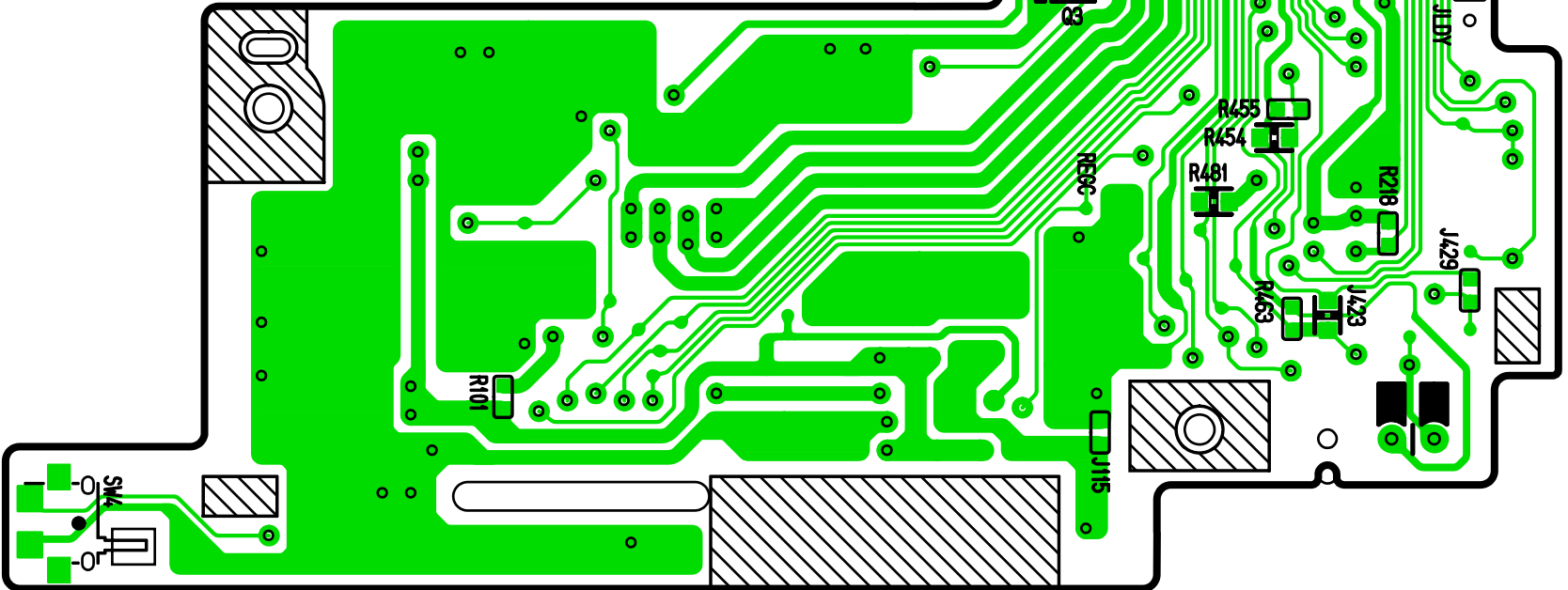

[E-8908Ab]

<TOP VIEW>

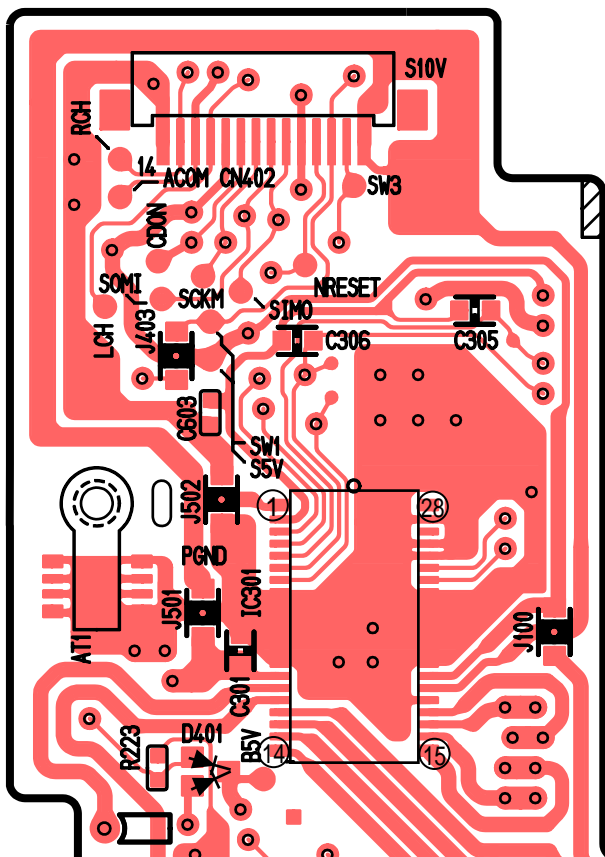
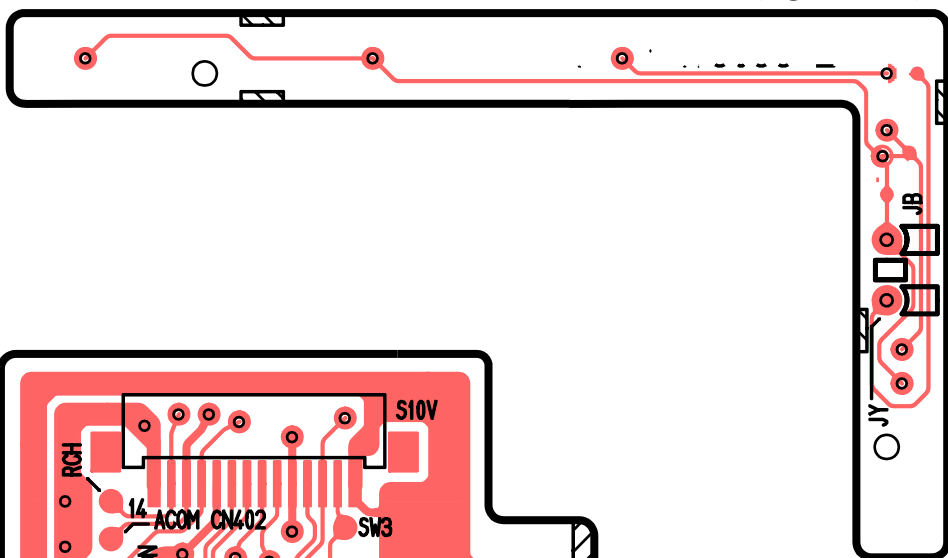

[E-8908Ac]

<TOP VIEW>

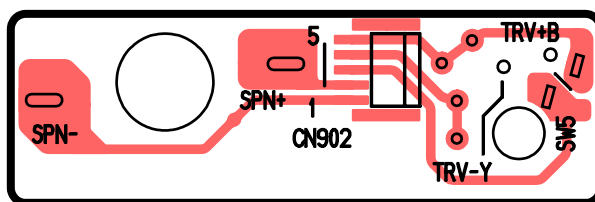

[E-8908Aa]

<TOP VIEW>

