

BOTTOM VIEW OF PRINTED CIRCUIT BOARD

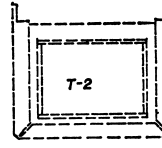

Variable Resistor for Tone

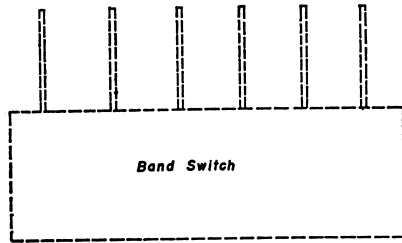
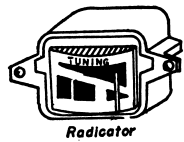
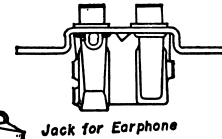
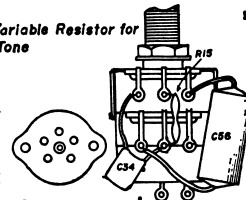

Socket

Variable Resistor for Off and Volume

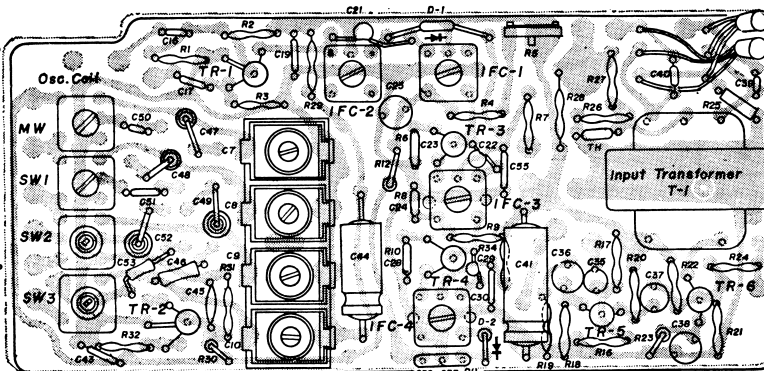
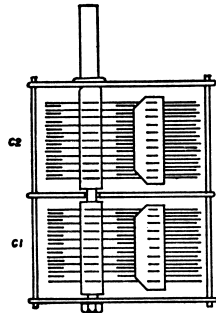

Variable Air Condenser

Trimmer

Terminal for Earth and Ext. Ant.

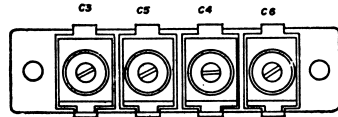

Jack for Ext. Battery

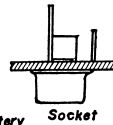

Matching Transformer

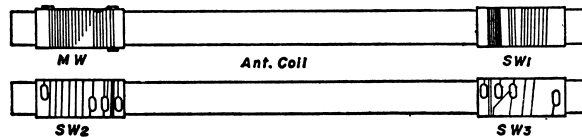
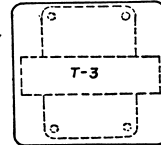

SCHEMATIC DIAGRAM

SHARP BZ-780

S154

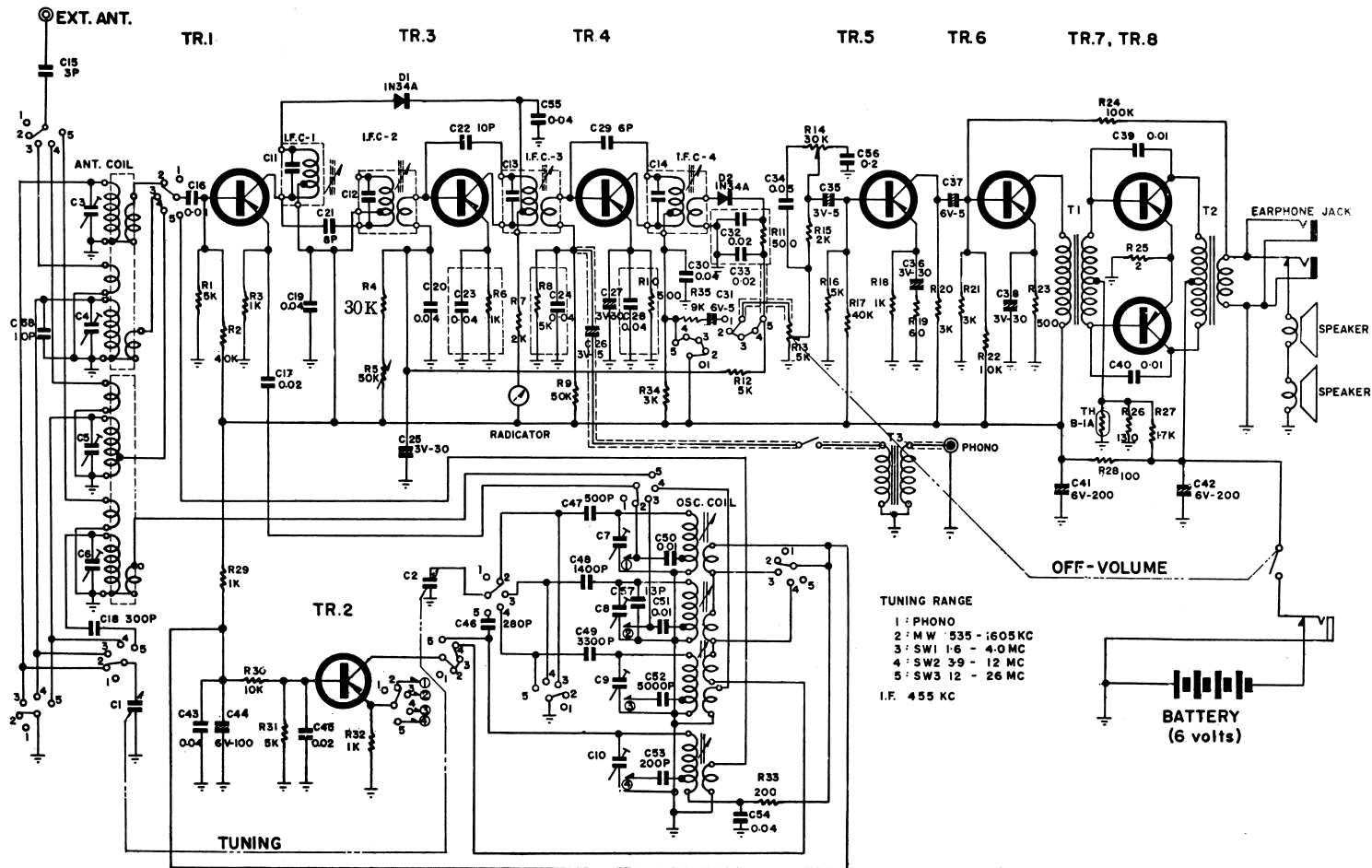

TUNING RANGE
 1: PHONO
 2: MW 535 - 1605 KC
 3: SW1 1.6 - 4.0 MC
 4: SW2 3.9 - 12 MC
 5: SW3 12 - 26 MC
 I.F. 455 KC

BATTERY
 (6 volts)