

# MEDIUM and LONG WAVE MODEL

MODEL 60T

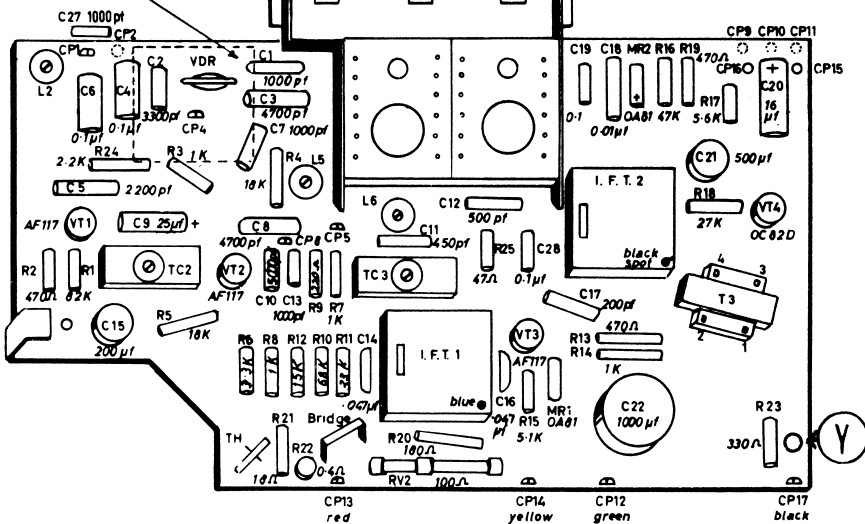

MAIN PANEL - COMPONENT LOCATION

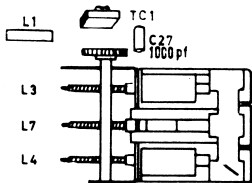

# MEDIUM WAVE or BROADCAST BAND MODEL

MODEL 62T

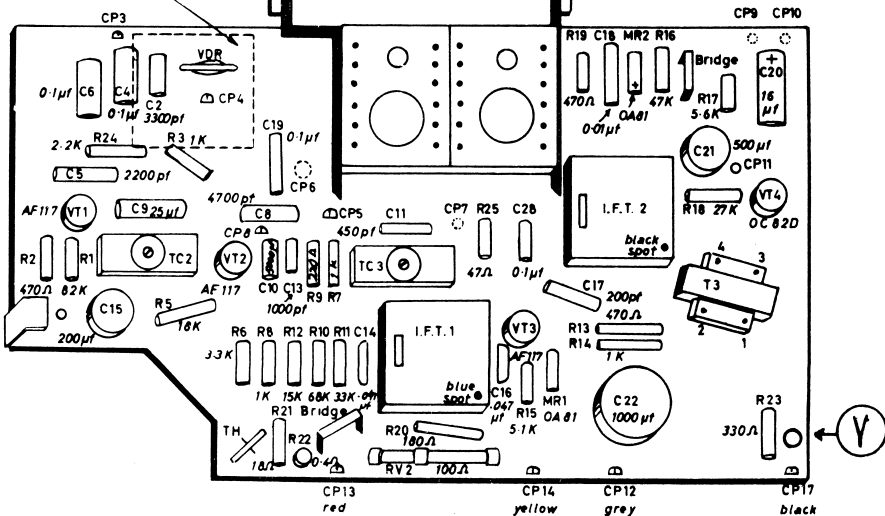

MAIN PANEL - COMPONENT LOCATION

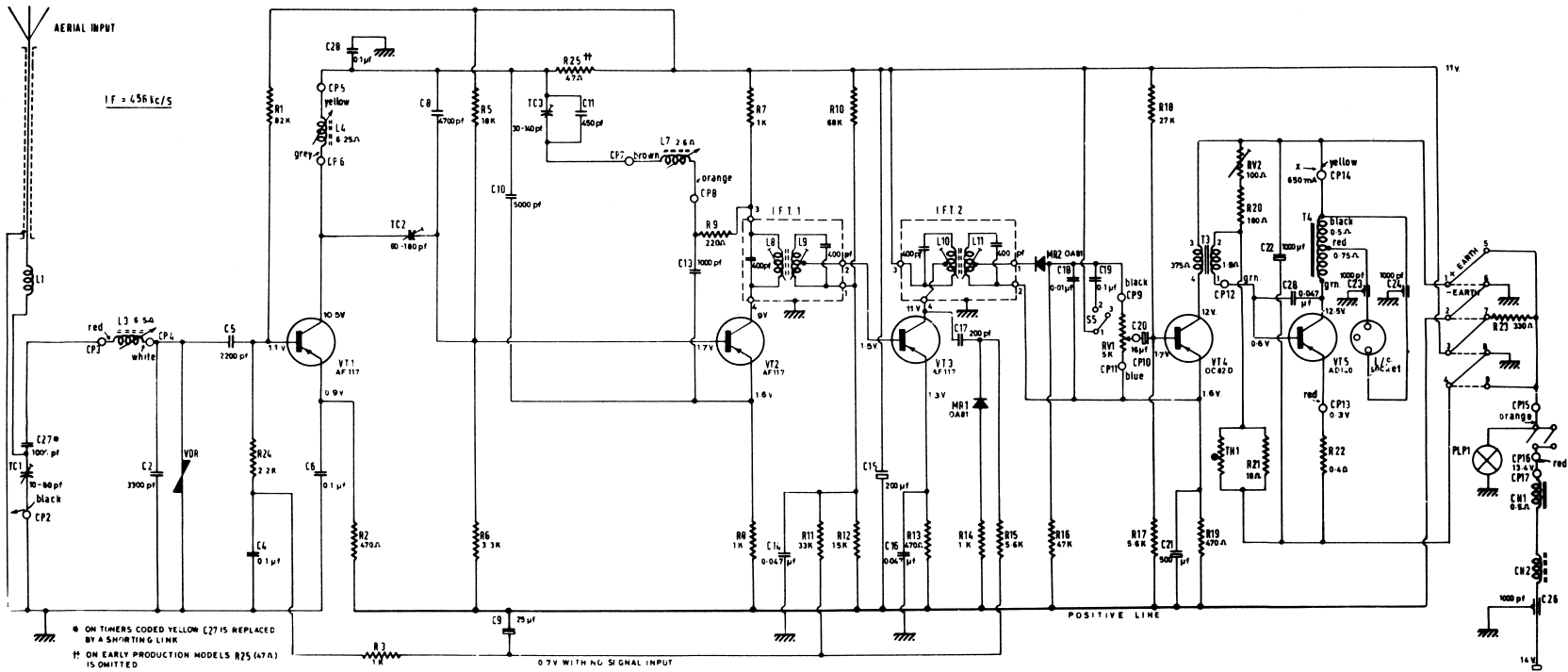

\* ON TIMERS CODED YELLOW C27 IS REPLACED BY A SHORTING LINK  
 † ON EARLY PRODUCTION MODELS R25 (47A) IS OMITTED

0.7V WITH NO SIGNAL INPUT

interlead shield & metal case

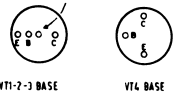

VT1-2-3 BASE

VT4 BASE

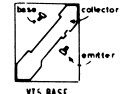

VT5 BASE

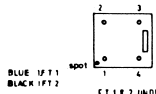

BLUE IFT1  
BLACK IFT2

IFT1 & 2 UNDERSIDE

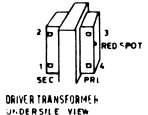

DRIVER TRANSFORMER  
UNDERSIDE VIEW

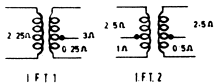

IFT1

IFT2

# HMV CAR RADIO MODEL 62T