

INSTRUMENT HANDBOOK

Applicable to Serial No. *14.655*

MODEL bwd 582

T.V. VIDEO WAVEFORM MONITOR

<u>SECTION</u>	<u>PAGE</u>	<u>CONTENTS</u>
1	1	GENERAL
2	1	SPECIFICATION
3	3	INSTALLATION INSTRUCTION
4	3	OPERATING INSTRUCTIONS
5	4	FIRST TIME OPERATION
6	5	CIRCUIT DESCRIPTION
7	7	ALIGNMENT AND MAINTENANCE
8	10	REPLACEMENT PARTS
9	10	WARRANTY

B.W.D. ELECTRONICS PTY.LTD.
331-333 BURKE ROAD, GARDINER
VICTORIA 3146 AUSTRALIA

Telephone: 25-4425

B.W.D. ELECTRONICS PTY.LTD.
127 BLUES POINT ROAD, NORTH SYDNEY
NEW SOUTH WALES 2060 AUSTRALIA

Telephone: 929-7452

1. GENERAL. Model bwd 582 Video Waveform Monitor is a portable self contained, all solid state instrument suitable for both black and white or colour monitoring.

The vertical amplifier is provided with a network that can be switched in to limit the high frequency response to conform to the IRE standard. The normal response provides a 5% level from 50Hz to 4.5MHz.

Internal calibrator produces a selectable .714 or 1V P-P 40kHz square wave for calibrating the vertical amplifier.

The cabinet design is based on a 7" x 1/2 rack module size permitting bench mounting. 19" x 7" rack mounting or two units side by side in a 7 x 19" rack utilizing bwd rack adaptors.

2. VERTICAL DEFLECTION SYSTEM.

2.1 Deflection Sensitivity: Continuously variable from 0.4V to 4V for 140 IRE units (7cms).

Frequency Response: (Sensitivity 1V for 140 IRE units).

Normal. 50Hz to 4.5MHz +0 -5%
3.5Hz to 8MHz - 3db.

IRE 235-1 standard.
Flat to 350kHz - 2%
20db down at 4MHz.

NOTE: Amplifier response is adjusted for optimum at a sensitivity of 1V for 140 IRE units. Sensitivity range from .5V to 1.5V for 140 IRE units will not affect the Normal response by more than 5%. Maximum variation over the entire sensitivity range will not exceed 10% of the specified frequency response at 1V.

Linearity: within 2% on the screen.

DC Restorer: Back porch clamping, does not affect colour burst signal.

Signal or Video Input: Bridged 75Ω compensated signal input via two Fernsh sockets. Input socket provides a 75Ω terminated input. Output socket provides a high impedance (1MΩ approximately) termination.

Signal may be applied with negative going sync pulses (Panel select to Normal) or positive going sync pulses (Panel switch to inverted).

2.2 HORIZONTAL DEFLECTION SYSTEM.

Sweep Rates: (Uncalibrated) 1 Line, 2 lines, 1 frame or 2 frames.
X5 magnifier available for both line and frame selection.

Unblanking: DC coupled to CRT unblanking electrode.

2. VERTICAL DEFLECTION SYSTEM (Contd.)

Sync: Internal.
External.

Sync obtained from vertical amplifier signal.

Ext trigger input is fitted to rear panel a .5V to 5V composite or non composite negative going sync pulse is required. Rear panel switch selects Internal-External Sync source.

AMPLITUDE CALIBRATOR.

Frequency approximately 40kHz amplitude selectable, .714 or 1V, accuracy 2%.

External calibrator may be applied through signal OUTPUT socket (1M Ω termination).

2.3 CRT.

5" flat face PDA operating at 2.9kV.
Viewing area 8 x 10cm.

Graticule:

Calibrated display area 7 x 10cm
Engraved from -40 to +100 every 10 units. Other graticules available to special order.
Graticule is provided with variable edge illumination and a green filter to increase contrast ratio.

2.4 POWER REQUIREMENTS.

90V to 135V or 185 to 265V 48 to 65Hz. Internal tappings located on Power Transformer.
30 watts max.

DIMENSIONS.

Bench mounted 7 $\frac{3}{4}$ " high x 8 $\frac{1}{4}$ " wide x 17 $\frac{1}{4}$ " deep overall feet knobs etc.
Rack mounted - single or dual units.
7" high x 19" x 16 $\frac{1}{2}$ " deep behind panel.
Weight 15 lbs.

3. INSTALLATION INSTRUCTIONS.

3.1 Modelbwd 582 utilises convection cooling to reduce internal temperature rise, Installation should be arranged to ensure ventilation holes in bottom cover are not obstructed nor hot air from other equipments below it allowed to enter and thus increase the internal operating temperature.

3.2 Power supply voltage should be checked against the transformer tapping. If instrument is supplied with standard Australian 3 pin plug on cord and no label attached to power cord transformer will be set to 235V tapping. If tapping has been set for other voltages a label attached to power cord will indicate this.

Transformer tappings are shown below and should be adjusted to suit supply if necessary. Fuse is a .5Amp for 230V use or 1A for 110V operation. Fast blow.

4. OPERATING INSTRUCTIONS (Contd.)

<u>Horizontal Position X5 mag.</u>	When control knob is pulled out trace is expanded X5 irrespective of selection of Time Base switch. Rotation of knob in OUT position move the trace horizontally to permit examination of any point on the display.
<u>Vertical Position .</u>	Moves trace vertically over display area .
<u>Normal - Invert.</u>	Switch permits correct display of video signal irrespective of input polarity.
<u>Normal - IRE.</u>	Two position switch selects amplifier response. Normal - flat from 50Hz to 4.5MHz - 5% IRE - -20db at 4MHz.
<u>Cal. (Preset)</u>	Screwdriver control to set the instrument sensitivity over a 10-1 range.
<u>Cal. - Use .</u>	Three position switch selects either 1V or .714V amplitude calibrate signal or the input video signal to display on CRT..
<u>REAR PANEL:</u>	
<u>Int.-Ext. Sync</u>	When switched to Internal, sync selector uses internal signal display for locking. In Ext. position internal sync is disconnected and composite video or non-composite sync signals applied to Ext. sync socket lock trace. Input should be .5V to 5V amplitude.
<u>Input Socket .</u>	Fernsh input socket with internal 75 Ω termination.
<u>Output Socket .</u>	Fernsh socket fitted with switch controls which open 75 Ω termination when plug is pushed in. When a feed through connection is required feed input cable to Input socket and output to output socket. 75 Ω termination is removed but feed through components retain a constant 75 Ω impedance.

5. FIRST TIME OPERATION.

5.1 Connect instrument to correct AC power source (see para . 3.2) and set controls as follows:

Time Base	Line 2.
Horizontal Position	Pushed in.
Vertical Position	Centred.
Normal-Invert	Normal,
Normal-IRE	Normal,
Cal - Use	.714 (centre position).
Focus .	Centre.
Intensity	$\frac{1}{4}$ rotation clockwise.
Graticule	Switch on by rotating clockwise.

INSTRUMENT HANDBOOK

Applicable to Serial No. *14655*

MODEL bwd 582

T.V. VIDEO WAVEFORM MONITOR

<u>SECTION</u>	<u>PAGE</u>	<u>CONTENTS</u>
1	1	GENERAL
2	1	SPECIFICATION
3	3	INSTALLATION INSTRUCTION
4	3	OPERATING INSTRUCTIONS
5	4	FIRST TIME OPERATION
6	5	CIRCUIT DESCRIPTION
7	7	ALIGNMENT AND MAINTENANCE
8	10	REPLACEMENT PARTS
9	10	WARRANTY

B.W.D. ELECTRONICS PTY.LTD.
331-333 BURKE ROAD, GARDINER
VICTORIA 3146 AUSTRALIA

Telephone: 25-4425

B.W.D. ELECTRONICS PTY.LTD.
127 BLUES POINT ROAD, NORTH SYDNEY
NEW SOUTH WALES 2060 AUSTRALIA

Telephone: 929-7452

6. CIRCUIT DESCRIPTION (Contd)

Current flowing through the output stage is applied to a 10V zener diode D15 to provide a 10V stabilised rail to drive Q1 and Q2, the sync separator circuits and the calibrator. C13 filters signals present in the emitter load of Q8 and 10 and those generated by the calibrator and sync separator circuits.

6.2 Input signals from the vertical amplifier feed via C3 to Q14 phase splitter. Signals appearing at the emitter are in phase with the input whilst those at the collector are inverted. The appropriate signal with negative going sync pulses is selected by S4C which is part of the polarity selector switch S4A & B coupling the input of Q3 and Q4 amplifiers to the input signal. The negative going sync pulses are applied to Q15 grounded emitter stage via C24 and R58. As R58 is connected to ground Q15 is conducting with its collector around 9V. The negative going sync pulse tips will drive the stage further into conduction however, when the sync pulse rises back to black level it immediately cuts off Q15, its collector falls and an amplified, clean sync pulse is developed across R59.

Q16 is another grounded emitter stage which will further clip the sync pulse to ensure no video information is contained in the waveform appearing across R62. Three outputs are taken from R62. The line sync pulses are taken directly to S6A whilst frame pulses are integrated by R67-68 and C28 before connecting to S6A. The third signal is taken via C26 R64 to Q17. The line pulses are differentiated by C26 and clipped by D7, R62 and R63. Equal positive and negative pulses are produced by Q17 across the low impedance loads R66 and R65 with a pulse width of approximately 1 μ Sec.

These pulses are fed to the DC restorer via C5 & 6.

6.3 DC Restorer.

To ensure the signal remains stable on the CRT irrespective of variations in the video content or even sync pulse amplitude particularly when monitoring 'off the air' signals from a T.V. receiver, the signal must be clamped to a particular level. In this model clamping is held at the level of the back porch, directly following the sync pulse but short enough to not interfere with a colour sync burst when present.

The two symmetrical 1 μ Sec pulses drive D1 and D2 hard into conduction producing a low impedance at the junction of the diodes and C4, the clamp voltage being at ground potential. Therefore following each line sync pulse the signal back porch level is clamped to ground and due to the long time constant of the circuit formed by C4, the leakage of D1 and D2 and the gate current of Q3 or Q4 no drift of this level will occur between successive sync pulses. The vertical amplifier is DC coupled from the DC restorer to the deflection plates so restoration is maintained throughout the deflection system.

6.4 The Time Base consists of a sync shaping circuit Q18 - Q20, sweep gate Q22 and 23, Miller Sawtooth generator Q24-26, Auto gate circuit Q21 and horizontal amplifier Q28-30.

Line or frame sync pulses selected by S6A are coupled to Q18 emitter follower isolation stage which drives at low impedance the pulse shaping Schmitt Trigger pair Q19 and 20. Irrespective of the shape or rise time of the input, the signal developed across R77 has a constant amplitude and fast fall time. The negative pulse is differentiated by C35 and used to trigger the time base gate Q22 and Q23. In the quiescent condition awaiting

6. CIRCUIT DESCRIPTION (Contd)

The time base sawtooth is taken from the junction of R104 and R106 via R107 and C43 to the base of Q28. Shift voltages are added to the signal via R100, R109 and RV16 panel preset and in the X5 magnified position by R108, S7 and RV15 front panel shift control. The horizontal amplifier is similar to the vertical output stage being a high voltage balanced cascode stage with preset gain controls between the emitters of Q28 and 30.

Gain is increased by X5 when RV18 is paralleled across RV17.

6.5 The calibrator is an emitter coupled multi vibrator Q11 and Q12 oscillating at approximately 50kHz. The output waveform is clipped on the positive face to eliminate tilt by D16 which conducts at 3.3V when D17 sener conducts. This charges C22 and provides a low impedance clamp source.

RV11 and 12 presets are adjusted for .714 and 1V P-P output.

6.6 Transformer T1 supplies all voltages to the instrument. Low voltages are + and - 50V approx. and +200. -55 is half wave rectified by D6 and filtered by C19, R43 and C20. A further stage of filtering by R119 and C29 reduces the rail to -45V +50V is similarly obtained from half wave rectifier D5 with C17, R42, C18 filters. A further stage of filtering is obtained from R22, R21 and C9 for the +24 rail in the vertical amplifier.

The high voltage for the deflection amplifiers is obtained by doubling an 82V winding by D3, D4, C14 and 15. Separate filters are used for each amplifier. R44 and C10 for the vertical ampltier, R41 and C16 for the horizontal.

The CRT operates on approximately equal + and - voltages. Negative 1400 is full wave doubled by D201 and 202, C201, 2, 3 and 4. +1500 by half wave doubling via C209, D203 and D204.

CRT intensity and focus controls are placed in a divider chain across the -1400 rail. Astigmatism and geometry controls are connected into the low voltage supplies.

7. ALIGNMENT AND MAINTENANCE.

7.1 Access to Model WF 582 can be obtained by removing two screws holding down the handle, this enables the top portion of the cover to be lifted off. Removal of the 4 feet underneath enables the bottom cover to be removed for complete access to all parts.

Complete alignment can be made using a video waveform generator or the video output from a T.V. receiver plus a square wave generator (10 nSec rise time) and a constant amplitude sine wave generator.

7.2 The first adjustment is to set the DC level of the vertical output stage. Switch to 2 frames on Time Base switch with no input. Centre trace vertically. Measure with a 20,000 Ω /Volt meter the average voltage on Q27 and Q29 collectors (approximately +95V). Now adjust RV4 (RH rear of board) until average voltage on Q7 and 9 collectors is within 5V of the horizontal amplifier voltage.

3. INSTALLATION INSTRUCTIONS (Contd.)

UNIVERSAL TRANSFORMER CONNECTION

200-240V CONNECTIONS

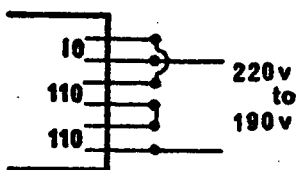
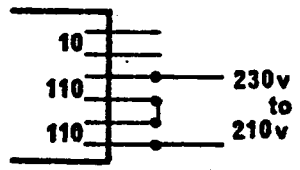
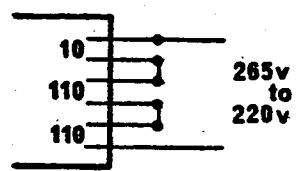

100-120V CONNECTIONS

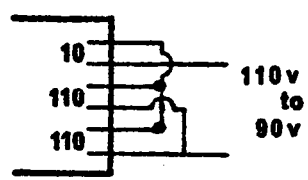
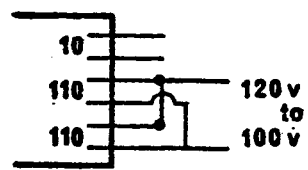
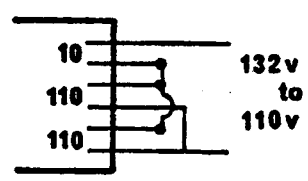

3.3 19" Rack mounted versions will require rack adaptors to convert them for 19" use. For single unit mounting, bwd R76 adaptors are required. For dual mounting, bwd R75 rack adaptor is required. Holes in angle bolting faces conform to standard 19" rack dimensions.

4. OPERATING INSTRUCTIONS.

4.1 FRONT PANEL CONTROLS:

Graticule - OFF

Fully anticlock this control switches off the AC power. Clockwise rotation increases graticule illumination.

Intensity

Controls CRT brightness.

Focus.

Control to adjust the beam for maximum trace sharpness.

Astigmatism. (Preset)

Used initially with focus control to obtain a uniform focus over most of the screen area.

Time Base.

Selects 1 or 2 frame signals or 1 or 2 line signals.

Horizontal Position (Preset)

Adjusts horizontal position of trace when non magnified.

5. FIRST TIME OPERATION (Contd.)

5.2 Adjust the intensity when display appears to a suitable intensity for good viewing and focus for a sharp overall display.

Centre trace and observe display, switch to 1V cal. waveform, adjust CAL preset for 140 IRE units. .714 waveform will now equal 100 units.

5.3 If an external calibration signal is to be used feed it into the OUTPUT socket on rear panel (input impedance 1M Ω) and switch selector to USE. Input frequency of ext. CAL waveform must be greater than 1kHz.

5.4 As Internal calibrate waveform is at 50kHz approximately only two horizontal lines will be displayed in the frame positions of the Time Base switch.

5.5 When a video signal is fed in it should appear with the sync pulses at the bottom of the display, if inverted change over the Normal-Inverted switch for correct display and recentre trace.

5.6 If it is desired to match the display to the graticule adjust the CAL preset until the sync pulses are equal to 40 divisions with the top of the sync pulse i.e. back and front porch level located on the graticule 0 line. Maximum white video signal should not exceed 100 IRE units on the graticule.

6. CIRCUIT DESCRIPTION.

The monitor will be divided into the following sections:

1. Vertical amplifier.
2. Sync Separator.
3. DC restorer.
4. Time Base and Horizontal Amplifier.
5. Calibrator.
6. Power Supplies and CRT.

6.1 Input signals applied to the rear panel sockets are taken by co-ax. cable to the Input-Calibrator Selector switch. In the Use position signals are taken through a protection divider R2 C44 and R3 to Q1 FET source follower. Two outputs are taken from the FET, one via C3 to the sync phase splitter and the second via C2 to the front panel CAL control RV1. Output from RV1 drives the base of Q2 emitter follower. This provides a low output impedance to drive the pulse clamp restoration circuit, the IRE filter when switched in by S3A & B and the input amplifiers Q3 & Q4 via Normal-Inverting Switch S4A & B.

Q3, Q4 long tailed pair produces a balanced output across the drain loads which is directly coupled to emitter followers Q5 and Q6.

Vertical positioning is applied to Q3 and Q4 drains via R11 and 16 from RV3 front panel Vertical Position control.

The CRT output deflection amplifier is a high voltage wide band cascode stage consisting of Q7 - 10. Balanced signals applied to Q8 and Q10 bases are amplified and driven into the emitters of Q7 and Q9 high voltage deflection plate drivers high frequency compensation is provided by RV5, C11 and C12. DC levels at the collectors are set by RV4 common emitter resistor.

MODEL 582 VIDEO WAVEFORM
MONITOR COMPONENT LAYOUT

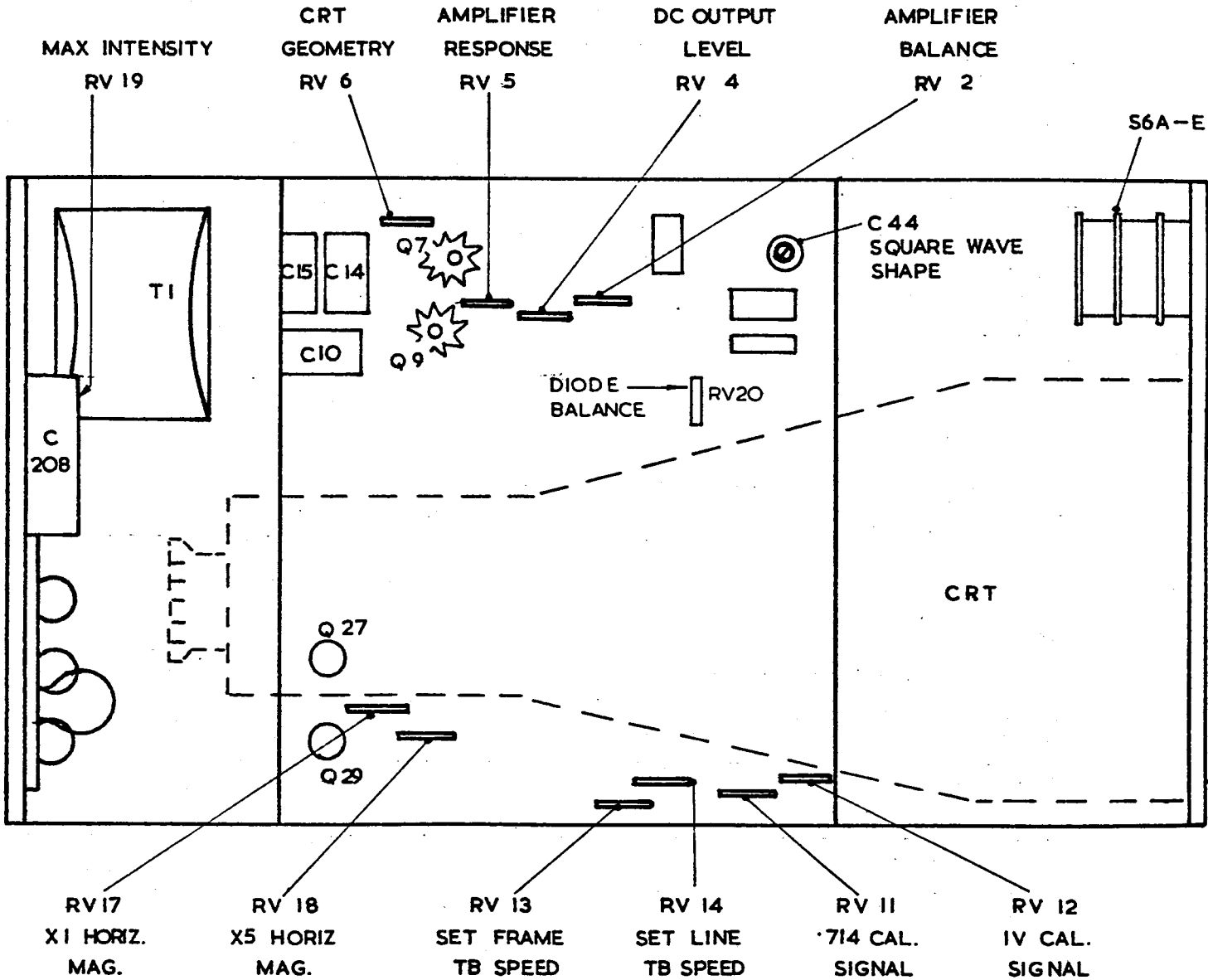

7. ALIGNMENT AND MAINTENANCE (Contd.)

Now feed in a 350kHz sine wave and adjust deflection to equal 140 IRE units.

Adjust FOCUS AND ASTIGMATISM for best focus over entire viewing area, then adjust RV6 geometry preset (RH rear of board) for best trace geometry with minimum pin-cushioning or barrel distortion. Turn intensity control fully clockwise, adjust RV19 on rear EHT board until flare is removed from display.

7.3 Feed in a IV square wave calibration signal and adjust vertical gain (Front panel CAL preset) for 140 IRE units. Switch over to IV CAL waveform, adjust RV12 (RH front of board) for 140 IRE DIV. Switch to .714 cal waveform adjust RV11 for 100 IRE units. The calibrator is now correct.

7.4 VERTICAL AMPLIFIER ALIGNMENT. - Do not move CAL preset during following tests.

Switch input to USE, feed in a 15kHz square wave 100 IRE units amplitude, Time Base at 2 line position. Adjust C44 (front LH side of board) for level tops to square wave - no rounding or overshoot.

Increase frequency to 100kHz square wave. Pull out X5 magnification control.

Adjust C12 and RV5 for optimum square wave with flat top. A slight single ring of approximately 2mm will be present when response is optimised.

Check operation of IRE response, waveform should be rounded with no ringing.

Replace square wave input with sine wave. Set level equal to 100 IRE units at 50kHz. In the normal position, bandwidth should not be greater than 5% down at 4.5MHz and -3db at 8MHz.

In the IRE position bandwidth should be 2% down at 350kHz and greater than 20db down at 4MHz. i.e. 5 IRE division max.

7.5 TIME BASE CALIBRATION.

Feed in a video waveform from a generator on an 'off the air' receiver. Set Time Base to 1 frame. Adjust RV17 preset (Rear LH side of board) for trace length equal to graticule calibration. i.e. 10cm approx. Centre trace with front panel Horizontal Position preset. Check trace position and length at other time base switch settings.

Reset Time Base switch to 1 frame, adjust RV14 until one complete frame signal is visible, switch to 2 frame position to check display. Set RV14 to optimise display between the two positions.

Change to 1 line and adjust RV13 for one complete line display. Switch to 2 lines and optimise setting of RV13 for best display in both positions.

Remove video signal and replace with square wave. Select 2 lines on Time Base, adjust external square wave for 5 complete waveforms equal to length of calibrated graticule. Pull out X5 mag knob then adjust RV18 (LH rear board) until one square wave equals length of calibrated graticule. Check that display can be tracked along to display both ends.

The instrument is now correctly aligned.

6: CIRCUIT DESCRIPTION (Contd.)

a trigger pulse, Q22 will be conducting and Q23 cut off. Q22 has its collector at approximately -4V which causes D11 to conduct and via R87, R89 divider to bias off Q23. As the CRT blanking electrode on pin 11 is connected to Q22 collector the CRT is blanked off whilst D12 connected to Q23 collector is held above ground by the divider R92, R93 and R90. This causes Q24 source to rise, it turns on Q25 causing its collector and hence Q26 base and emitter to fall until the junction of R104, R106 and D13 falls to a voltage which causes D13 to conduct. Conduction of D13 causes the voltage at the anode of D12 to be reduced as current is now by passed through R106 and 105 to the -45V rail. A quiescent state is reached where the bypass current through D13 just holds the forward bias voltage on Q24 and hence Q25 at a level which keeps D13 conducting.

On the arrival of negative trigger pulse at Q22 base the transistor is cut off, its collector rises turning on the CRT beam blanking, Q23 turns on via the voltage divider D11, R87 and R88 permitting its emitter current to take over from Q22 so biasing it off completely.

Conduction through Q23 causes its collector voltage to fall reverse biasing D12 and D13 thus leaving the Miller circuit ready to operate. Q24 gate is returned to a negative voltage via the timing resistors R97-100 as selected by S6D. This tends to cut Q24 off and reduce the bias on Q25, its collector rises pulling up Q26 base, its emitter rises and via R104 and C42 change the selected timing capacitors C40 and 41. As the other end of the timing capacitors are taken back to Q24 gate the positive going charge applied is in opposition to the negative fall created by the charging resistors.

As a result of this feed back an extremely linear rising voltage is developed across the Miller transistor Q25 and by the emitter follower action across the output load R105 & 6. It will continue to rise until the voltage at the junction of these resistors and D14 reaches approximately -6V when D14 conducts and starts to charge C36 hold-off capacitor and C33 in the frame positions and increase the bias on Q22 base. When the base rises to about -3V Q22 conducts, its collector falls, blanks the CRT, and again cuts off Q23 so that its collector rises, D12 conducts, biases Q25 on hard, its collector falls together with Q26 until as previously described, D13 conducts and a quiescent condition is again established.

The base of Q22 will not fall immediately D14 disconnects as the hold off capacitor will require discharging through R81 and Q22 base current. This time delay is sufficient to prevent triggering before C40 or C41 have discharged to the quiescent condition.

If no trigger pulse is received the gate circuit Q22 and 23 are automatically operated at a rate slightly longer than the duration of two lines or two frames as selected by S6.

Q21 controls the auto circuit. During the time the sawtooth waveform is developed Q21 is turned on causing its collector to rise to zero and discharge C34 and C31 when switched to frame. At the commencement of the flyback Q21 is cut off and C34 and C31 can charge negatively via the divider R78, 79, 80 and 81. This steadily reduces the bias on Q22 base until it is unable to hold it in conduction its collector rises, unblanking the CRT and turning Q23 on thus initiating another trace where no sync signal was present.

MODIFICATIONS

ISSUE 1 11-69

ISSUE 2 4-70

PRODUCTION.

ISSUE 3 5-70

RV19 ADDED

CALIBRATOR REDESIGNED

ISSUE 4 7-70

R44 WAS 3-9K4W

R120 ADDED

C22 WAS .1

ISSUE 5 9-70

TRACED

ISSUE 6

INT. EXT. SYNC. SKT.

ADDED S8.

SWITCHES

S1 75 Ω TERMINATION

S2A & B USE/CALIBRATE

S3A & B FLAT - IRE RESPONSE

S4A - C NORM - INVERT

S5A & B POWER ON-OFF

S6A - E TIME BASE SELECTOR

S7A & B x5 MAGNIFICATION

S8 INT EXT. SYNC.

CONTROLS

RV1 CALIBRATE (AMPL. SENS.)

RV2 VERT. BALANCE

RV3 VERT. POSITION

RV4 AMPLIFIER DC LEVEL

RV5 AMPLIFIER RESPONSE

RV6 GEOMETRY (CRT)

RV7 ASTIGMATISM (CRT)

RV8 FOCUS (CRT)

RV9 INTENSITY (CRT)

RV10 GRATICULE ILLUMINATION

RV11 -714V CAL SIGNAL

RV12 IV CAL SIGNAL

RV13 FRAME TIME BASE PRESET

RV14 LINE TIME BASE PRESET

RV15 HORZ SHIFT - x5 MAG. ONLY

RV16 HORZ POSITION PRESET

RV17 HORZ WIDTH

RV18 HORZ WIDTH x5 MAG.

RV19 SET MAX INTENSITY

RV20 DIODE BALANCE.

ABBREVIATIONS CONTINUED

PL	Plug	Se	Selenium
PS	Socket	SI	Slide
Preset	Internal Preset	SPDT	Single Pole Double Throw
PYE	Polyester	SPST	Single Pole Single Throw
pot	Potentiometer	si	Silicon
prec	Precision	Ta	Tantalum
PC	Printed Circuit	tol	Tolerance
PIV	Peak Inverse Voltage	trim	trimmer
PYS	Polystyrene	V	Volt (s)
p-p	Peak to Peak	var	variable
P.Shaft	Plain Shaft	vdcw	Volts Direct Current Working
S.Shaft	Slotted Shaft	w	Watt (s)
R	Resistor	ww	Wire Wound
rot	Rotary	Z	Zener
R log	Reverse Logarithmic Taper	*	Factory Selected valve average valve may be shown
rms	Root Mean Squared	**	Special Component, no part number assigned

MANUFACTURER ABBREVIATIONS

AC	Allied Capacitors	J	Jabel
AEE	AEE Capacitors	MAS	Master Instrument Co. Pty.Ltd.
AN	Anodeon	MUL	Mullard (Aust.) Pty.Ld.
AST	Astronic Imports	MOR	Morganite (Aust.) Pty.Ltd.
AWA	Amalgamated Wireless of Aust.	MSP	Manufacturers Special Products (AWA)
ACM	Acme Engineering Pty.Ltd.	McM	McMurdo (Aust.) Pty.Ltd.
AMP	Aircraft Marine Products (Aust)P/L	NU	NU VU Pty.Ltd.
AR	A. & R. Transformers	NAU	A.G. Naunton Pty.Ltd.
AUS	Australux Fuses	PA	Painton (Aust.) Pty.Ltd.
AWV	Amalgamated Wireless Valve Co.	PAL	Paton Elect. Pty.Ltd.
ACA	Amplifier Co. of Aust.	PI	Piher Resistors (Sonar Electronics)
AL	Alpha	PW	Precision Windings Pty.Ltd.
ARR	Arrow	PH	Philips Electrical Industries Pty.Ltd.
BWD	B.W.D. Electronics Pty.Ltd.	PL	Plessey Pacific
BL	Belling & Lee Pty.Ltd.	PV	Peaston Vic
BR	Brentware (Vic) Pty.Ltd.	RP	Radio Parts Pty.Ltd.
CF	Carr Fastener	RC	Radio Corporation (Electronic Inds.)
CAN	Cannon Electrics Pty.Ltd.	RCA	Radio Corporation of America
CIN	Cinch	RHC	R.H. Cunningham
D	Ducon Condensor Pty.Ltd.	S	Sonic Electronics Pty.Ltd.
DAR	Darstan	STC	Standard Telephones & Cables
DIS	Distributors Corporation Pty.Ltd.	SI	Siemens Electrical Industries
ELN	Elna Capacitors (Sonar Elect.P/L)	SIM	Simonson Pty.Ltd.
ETD	Electron Tube Dist.	SE	Selectronic Components
F	Fairchild Australia Pty.Ltd.	TR	Trimax Erricson Transformers
GRA	General Radio Agencies	TI	Texas Instruments Pty.Ltd.
GES	General Electronic Services	TH	Thorn Atlas
GL	Grelco	UC	Union Carbide
HW	Hurtle Webster	W	Wellyn Resistors (Cannon Elec.P/L)
HOL	R.G. Holloway	Y	F.L. Yott Pty.Ltd.
H	Haco Distributors (National)	Z	Zephyr Prod. Pty.Ltd.
		2B	

PARTS LIST MODEL bwd 582 VIDEO MONITOR

CCT Ref	DESCRIPTION				Mfr. of Supplier	PART NO.
	<u>RESISTOR</u>					
R42	1.2K Ω	$\frac{1}{2}$ w	5%	CC	PI	
R43	470 Ω	$\frac{1}{2}$ w	5%	CC	PI	
R44						
R45	5.6K Ω	$\frac{1}{2}$ w	5%	CC	PI	
R46	5.6K Ω	$\frac{1}{2}$ w	5%	CC	PI	
R47	2.2K Ω	$\frac{1}{2}$ w	5%	CC	PI	
R48	4.7K Ω	$\frac{1}{2}$ w	5%	CC	PI	
R49	5.6K Ω	$\frac{1}{2}$ w	5%	CC	PI	
R50	4.7K Ω	$\frac{1}{2}$ w	5%	CC	PI	
R51	1.5K	$\frac{1}{2}$ w	5%	CC	PI	
R52						
R53						
R54	68K Ω	$\frac{1}{2}$ w	5%	CC	PI	
R55	22K Ω	$\frac{1}{2}$ w	5%	CC	PI	
R56	2.2K Ω	$\frac{1}{2}$ w	5%	CC	PI	
R57	2.2K Ω	$\frac{1}{2}$ w	5%	CC	PI	
R58	3.3M Ω	$\frac{1}{2}$ w	5%	CC	PI	
R59	18K Ω	$\frac{1}{2}$ w	5%	CC	PI	
R60	1M Ω	$\frac{1}{2}$ w	5%	CC	PI	
R61	4.7K Ω	$\frac{1}{2}$ w	5%	CC	PI	
R62	4.7K Ω	$\frac{1}{2}$ w	5%	CC	PI	
R63	2.2K Ω	$\frac{1}{2}$ w	5%	CC	PI	
R64	10K Ω	$\frac{1}{2}$ w	5%	CC	PI	
R65	1K Ω	$\frac{1}{2}$ w	5%	CC	PI	
R66	1K Ω	$\frac{1}{2}$ w	5%	CC	PI	
R67	22K Ω	$\frac{1}{2}$ w	5%	CC	PI	
R68						
R69	680K Ω	$\frac{1}{2}$ w	5%	CC	PI	
R70	100K Ω	$\frac{1}{2}$ w	5%	CC	PI	
R71	82K Ω	$\frac{1}{2}$ w	5%	CC	PI	
R72	10K Ω	$\frac{1}{2}$ w	5%	CC	PI	
R73	1K Ω	$\frac{1}{2}$ w	5%	CC	PI	
R74	12K Ω	$\frac{1}{2}$ w	5%	CC	PI	
R75	33K Ω	$\frac{1}{2}$ w	5%	CC	PI	
R76	82K Ω	$\frac{1}{2}$ w	5%	CC	PI	
R77	3.3K Ω	$\frac{1}{2}$ w	5%	CC	PI	
R78	33K Ω	$\frac{1}{2}$ w	5%	CC	PI	
R79	6.8K	$\frac{1}{2}$ w	5%	CC	PI	
R80	2.2K Ω	$\frac{1}{2}$ w	5%	CC	PI	
R81	220K Ω	$\frac{1}{2}$ w	5%	CC	PI	
R82	47K Ω	$\frac{1}{2}$ w	5%	CC	PI	

8. REPLACEMENT PARTS.

As the policy of B.W.D. ELECTRONICS PTY. LTD. is one of continuing research and development, the company reserves the right to supply the latest equipment and make amendments to circuits and parts without notice.

9. GUARANTEE.

The equipment is guaranteed for a period of twelve (12) months from the date of purchase, against faulty materials and workmanship, with the exception of Cathode Ray Tubes, which are covered by their manufacturer's own warranty.

Please refer to Guarantee Registration Card No... *9268*which accompanied instrument, for full details of conditions of warranty.

REPLACEABLE PARTS

1. This section contains information for ordering replacement parts, it provides the following details:-
 - (a) Description of part (see list of abbreviations).
 - (b) Typical manufacturer or supplier of the part (see list of abbreviations).
 - (c) Manufacturer's Part Number; and
 - (d) Defence Stock Number, where applicable.

2. Ordering - Please quote Model Type No. e.g. bwd 511, Serial No., Circuit reference No. and component details as listed in parts list.

COMPONENT DESIGNATORS

A	Assembly	H	Heater	RV	Resistor Variable
B	Lamp	J	Jack (socket)	S	Switch
C	Capacitor	L	Inductor	T	Transformer
D	Diode	M	Meter	TH	Thermistor
DL	Delay Line	P	Plug	V	Valve
E	Misc. Elect. Part	Q	Transistor	VDR	Voltage Dependent Resistor
F	Fuse	R	Resistor		

ABBREVIATIONS

Amp	Ampere	L	Inductor
C	Capacitor	lin	Linear
cc	Cracked Carbon	Log	Logarithmic Taper
c	Carbon	m	Milli = 10^{-3}
cd	Deposited Carbon	MHz	Mega Hertz = 10^6 Hz
comp	Composition	MF	Metal Film
CDS	Ceramic Disc Capacitor	ma	Milli Ampere
cer	ceramic	MΩ	Meg Ohm = 10^6 Ω
Com	Common	mfr	Manufacturer
DPST	Double Pole Single Throw	MO	Metal Oxide
DPDT	Double Pole Double Throw	MHT	Polyester/Paper Capacitor
elec	Electrolytic	MPC	Metalised Polyester Capacitor
F	Farad	Ne	Neon
f	Fuse	NPO	Zero temperature co-efficient
FET	Field Effect Transistor	nsr	Not separately replaceable
Ge	Germanium	NC	Normally Closed
H	Henry (ies)	NO	Normally Open
H.S.	High Stability	ns	Nano second
HTC	High Temp Coating	obd	Order by Description
ins	Insulated	OD	Outside Diameter
kHz	Kilo Hertz = 10^3 Hz	p	Peak
KΩ	Kilohm = 10^3 Ω	pf	pico farad = 10^{-12} F

PARTS LIST MODEL bwd 582 VIDEO MONITOR

CCT Ref	DESCRIPTION				Mfr. or Supplier	PART No.
R203	560K	$\frac{1}{2}$ w	5%	CC	PI	
R204	560K	$\frac{1}{2}$ w	5%	CC	PI	
R205	82 Ω	$\frac{1}{2}$ w	5%	CC	PI	
<u>CAPACITOR</u>						
C1	0.47 μ F	200V	10%	PYE	SON	TYPE N
C2	125 μ F	16V		ELEC	PH	C426AR/E125
C3	10 μ F	64V		ELEC	PH	C426AR/H10
C4	0.01 μ F	100V	10%	PYE	SON	TYPE N
C5	0.01 μ F	160V	10%	PYE	PH	C296AR/A10K
C6	0.01 μ F	160V	10%	PYE	PH	C296AR/A10K
C7	120pf	630V	5%	PYS	AC	TCS106
C8	32 μ F	64V		ELEC	PH	C426AR/H32
C9	64 μ F	64V		ELEC	PH	C437AR/H64
C10	40 μ F	200V		ELEC	PH	C436AR/L40
C11	330pf	680V	5%	PYS	AC	TCS606
C12	20-220pf	Trimmer		MICA	DUC	CWO
C13	125 μ F	16V		ELEC	PH	C426AR/E125
C14	50 μ F	150V		ELEC	PH	C436AR/K50
C15	50 μ F	150V		ELEC	PH	C436AR/K50
C16	40 μ F	200V		ELEC	PH	C436AR/L40
C17	64 μ F	64V		ELEC	PH	C437AR/H64
C18	100 μ F	64V		ELEC	PH	C437AR/H100
C19	64 μ F	64V		ELEC	PH	C437AR/H64
C20	100 μ F	64V		ELEC	PH	C437AR/H100
C21	0.0056	400V	10%	PYE	PH	C
C22	0.22 μ F	100V	10%	PYE		
C23						
C24	0.1 μ F	100V	10%	PYE	SON	TYPE N
C25	0.47 μ F	100V	10%	PYE	SON	TYPE N
C26	100pf	500V	10%N750 CER		AC	CDS
C27						
C28	0.01 μ F	100V	10%	PYE	SON	TYPE N
C29	100 μ F	64V		ELEC	PH	C437AR/H100
C30	0.01 μ F	100V	10%	PYE	SON	TYPE N
C31	0.64 μ F	64V		ELEC	PH	C426AR/H0.64
C32	22pf	500V	10%N750 CER		AC	CDS
C33	0.1 μ F	100V	10%	PYE	SON	TYPE N
C34	0.0047pf	100V	10%	PYE	SON	TYPE N
C35	10pf	500V	10%	CER	AC	CDS
C36	0.0022	500V	20%	CER	AC	CDS

PARTS LIST MODEL bwd 582 VIDEO MONITOR

CCT Ref	DESCRIPTION				Mfr. or Supplier	PART No.	
	<u>POTENTIOMETER</u>						
RV14	100KΩ	PRE SET POT		C	PH	E097AC/100K	
RV15	100KΩ	LIN POT DPST Push Pull					
		Switch		C	DUC		
RV16	100KΩ	LIN POT SLOTTED SHAFT		C	SON		
RV17	10KΩ	PRE-SET		C	PH	E097AC/10K	
RV18	1KΩ	PRE-SET		C	PH	E097AC/1K	
RV19	100KΩ	PRE-SET		C	PH	E097AC/100K	
RV20	1MΩ	PRE-SET		C	PH		
	<u>DIODES</u>						
D1	75V	PIV	30mA	Si	PH	IN4148	
D2	75V	PIV	30mA	Si	PH	IN4148	
D3	400V	PIV	500mA	Si	STC	EM404	
D4	400V	PIV	500mA	Si	STC	EM404	
D5	400V	PIV	500mA	Si	STC	EM404	
D6	400V	PIV	500mA	Si	STC	EM404	
D7	75V	PIV	30mA	Si	PH	IN4148	
D8	75V	PIV	30mA	Si	PH	IN4148	
D9	75V	PIV	30mA	Si	PH	IN4148	
D10	75V	PIV	30mA	Si	PH	IN4148	
D11	75V	PIV	30mA	Si	PH	IN4148	
D12	75V	PIV	30mA	Si	PH	IN4148	
D13	75V	PIV	30mA	Si	PH	IN4148	
D14	75V	PIV	30mA	Si	PH	IN4148	
D15	10V	ZENER	400mA	Si	PH	BZ Y88/C10	
D16	100V	PIV	30mA	Ge	PH	OA91	
D17	3.3V	ZENER	400mW	Si	PH	BZ Y88/C3U3	
D18							
D19							
D20							
D201	SELENIUM RECTIFIERS				STC	K8/25	
D202	"	"			STC	K8/25	
D203	"	"			STC	K8/25	
D204	"	"			STC	K8/25	
	<u>TRANSISTORS</u>						
Q1	25V	Vds	N CHANNEL FET	Si	TI	2N3819	
Q2	20V	Vce	70 hfe NPN	Si	PH	BF194	
Q3	25V	Vds	N CHANNEL FET	Si	TI	2N3819) Matched pair
Q4	25V	Vds	N CHANNEL FET	Si	TI	2N3819	

PARTS LIST MODEL bwd 582 VIDEO MONITOR

CCT Ref	DESCRIPTION				Mfr. or Supplier	PART No.
	<u>RESISTOR</u>					
R1	75Ω	TR5	2%	MO	ELECTRICAL	
R2	220KΩ	1/2w	5%	CC	PI	
R3	1MΩ	1/2w	5%	CC	PI	
R4	22KΩ	1/2w	5%	CC	PI	
R5	470Ω	1/2w	5%	CC	PI	
R6	47KΩ	1/2w	5%	CC	PI	
R7	2.7M	1/2w	5%	CC	PI	
R8	2.7M	1/2w	5%	CC	PI	
R9	1.5KΩ	1/2w	5%	CC	PI	
R10	82Ω	1/2w	5%	CC	PI	
R11	100KΩ	1/2w	5%	CC	PI	
R12	1.8KΩ	1/2w	5%	CC	PI	
R13	470Ω	1/2w	5%	CC	PI	
R14	1.8KΩ	1/2w	5%	CC	PI	
R15	82Ω	1/2w	5%	CC	PI	
R16	100KΩ	1/2w	5%	CC	PI	
R17	82Ω	1/2w	5%	CC	PI	
R18						
R19	10KΩ	1/2w	5%	CC	PI	
R20	10KΩ	1/2w	5%	CC	PI	
R21	1.5KΩ	1/2w	5%	CC	PI	
R22	820Ω	1/2w	5%	CC	PI	
R23	82Ω	1/2w	5%	CC	PI	
R24	470Ω	1/2w	5%	CC	PI	
R25	5.6KΩ	1w	5%	CC	PI	
R26	5.6KΩ	1w	5%	CC	PI	
R27	470Ω	1/2w	5%	CC	PI	
R28	100Ω	1/2w	5%	CC	PI	
R29	100Ω	1/2w	5%	CC	PI	
R30	47Ω	1/2w	5%	CC	PI	
R31	82Ω	1/2w	5%	CC	PI	
R32						
R33	560KΩ	1w	5%	CC	PI	
R34						
R35	1.8MΩ	1/2w	5%	CC	PI	
R36						
R37						
R38						
R39						
R40						
R41	6.8KΩ	1/2w	5%	CC	PI	

CCT Ref	DESCRIPTION			Mfr. or Supplier	PART No.
	<u>RESISTOR</u>				
R83	220Ω	$\frac{1}{2}$ W	5%	CC	PI
R84	220KΩ	$\frac{1}{2}$ W	5%	CC	PI
R85	6.8 KΩ	$\frac{1}{2}$ W	5%	CC	PI
R86	68KΩ	$\frac{1}{2}$ W	5%	CC	PI
R87	15KΩ	$\frac{1}{2}$ W	5%	CC	PI
R88	22KΩ	$\frac{1}{2}$ W	5%	CC	PI
R89	120KΩ	$\frac{1}{2}$ W	5%	CC	PI
R90	3.3KΩ	$\frac{1}{2}$ W	5%	CC	PI
R91	47KΩ	$\frac{1}{2}$ W	5%	CC	PI
R92	150KΩ	$\frac{1}{2}$ W	5%	CC	PI
R93	3.3KΩ	$\frac{1}{2}$ W	5%	CC	PI
R94	39 KΩ	$\frac{1}{2}$ W	5%	CC	PI
R95	47KΩ	$\frac{1}{2}$ W	5%	CC	PI
R96	56KΩ	$\frac{1}{2}$ W	5%	CC	PI
R97	1MΩ	$\frac{1}{2}$ W	5%	CC	PI
R98	1MΩ	$\frac{1}{2}$ W	5%	CC	PI
R99	2.2MΩ	$\frac{1}{2}$ W	5%	CC	PI
R100	2.2MΩ	$\frac{1}{2}$ W	5%	CC	PI
R101	2.2KΩ	$\frac{1}{2}$ W	5%	CC	PI
R102	150Ω	$\frac{1}{2}$ W	5%	CC	PI
R103	33KΩ	$\frac{1}{2}$ W	5%	CC	PI
R104	2.7KΩ	$\frac{1}{2}$ W	5%	CC	PI
R105	18KΩ	$\frac{1}{2}$ W	5%	CC	PI
R106	12KΩ	$\frac{1}{2}$ W	5%	CC	PI
R107	100KΩ	$\frac{1}{2}$ W	5%	CC	PI
R108	270KΩ	$\frac{1}{2}$ W	5%	CC	PI
R109	330KΩ	$\frac{1}{2}$ W	5%	CC	PI
R110	100KΩ	$\frac{1}{2}$ W	5%	CC	PI
R111	82Ω	$\frac{1}{2}$ W	5%	CC	PI
R112	68KΩ	$\frac{1}{2}$ W	5%	CC	PI
R113	22KΩ	$\frac{1}{2}$ W	5%	CC	PI
R114	39KΩ	1W	5%	CC	PI
R115	39KΩ	1W	5%	CC	PI
R116	18KΩ	$\frac{1}{2}$ W	5%	CC	PI
R117	18KΩ	$\frac{1}{2}$ W	5%	CC	PI
R118	82Ω	$\frac{1}{2}$ W	5%	CC	PI
R119	470Ω	$\frac{1}{2}$ W	5%	CC	PI
R120					
R121	12K	$\frac{1}{2}$ W	5%	CC	PI
R201	560K	$\frac{1}{2}$ W	5%	CC	PI
R202	560K	$\frac{1}{2}$ W	5%	CC	PI

PARTS LIST MODEL bwd 582 VIDEO MONITOR

CCT Ref	DESCRIPTION					Mfr. or Supplier	PART No.
<u>TRANSISTORS</u>							
Q5	20V	Vce	70 hfe	NPN	Si	PH	BF 194
Q6	20V	Vce	70 hfe	NPN	Si	PH	BF194
Q7	150V	Vce	50mA 1.7W	NPN	Si	PH	BF178
Q8	20V	Vce	70 hfe	NPN	Si	PH	BF194
Q9	150V	Vce	50mA 1.7W	NPN	Si	PH	BF178
Q10	20V	Vce	70 hfe	NPN	Si	PH	BF194
Q11	-45V	Vce	75 hfe	PNP	Si	PH	BC157
Q12	-45V	Vce	75 hfe	PNP	Si	PH	BC157
Q13							
Q14	45V	Vce	125 hfe	NPN	Si	PH	BC147
Q15	-45V	Vce	75 hfe	PNP	Si	PH	BC157
Q16	45V	Vce	125 hfe	NPN	Si	PH	BC147
Q17	45V	Vce	125 hfe	NPN	Si	PH	BC147
Q18	45V	Vce	125 hfe	NPN	Si	PH	BC147
Q19	45V	Vce	125 hfe	NPN	Si	PH	BC147
Q20	45V	Vce	125 hfe	NPN	Si	PH	BC147
Q21	-45V	Vce	75 hfe	PNP	Si	PH	BC157
Q22	45V	Vce	125 hfe	NPN	Si	PH	BC147
Q23	45V	Vce	125 hfe	NPN	Si	PH	BC147
Q24	25V	Vds	N CHANNEL	FET	Si	TI	2N3819
Q25	45V	Vce	125 hfe	NPN	Si	PH	BC147
Q26	45V	Vce	125 hfe	NPN	Si	PH	BC147
Q27	150V	Vce	50mA 1.7W	NPN	Si	PH	BF179
Q28	45V	Vce	125 hfe	NPN	Si	PH	BC147
Q29	150V	Vce	50mA 1.7W	NPN	Si	PH	BF179
Q30	45V	Vce	125 hfe	NPN	Si	PH	BC147
<u>SUNDRIES</u>							
L2	100 μ H coil					Selectronics	VPC/100
VDR1	VDR (0.8w) RED/ORANGE/YELLOW					PH	E2990/P234
	P/C/BOARD EPOXY GLASS					PROCEL	160/107
	T05 HEAT SINKS					GES	
	P/C/BOARD EPOXY GLASS					PW	160/072
	LAMPS LES					GRA	E5/8
	RED BRACKET LAMP					SON	3280
S1	ON BACK OF INPUT SOCKET					PYROX	FERNSH
S2	2 POLE	3POS	SL	SW	HAYCO	RQ153S	
S3	2 POLE	2POS	SL	SW	SON	3570	
S4	3 POLE	3POS	SL	SW	McMURDO		
S5	ON BACK OF POT 50 Ω 2W WW					IRH	

CCT Ref.	DESCRIPTION	Mfr. or Supplier	PART No.	
	<u>SUNDRIES</u>			
S6	2 POLE 4 POS 3 DECK	AWA	TYPE F	
S7	ON BACK OF POT 100KA with Push-Pull DPST	DUC		
T1	POWER TRANSFORMER	ERIC	TP5698	
	CRT D13-27GH WITH SOCKET	PH	PH	
	SOCKET CO-AX	PYROX	FERN SH	
	SOCKET CO-AX WITH SWITCH	PYROX	FERN SH	
	FUSE CARTRIDGE 3AG	YOTT	0.5AMP	
	POWER CORD c/w PLUG	PEAS		
	ALL OTHER ITEMS ORDER BY DESCRIPTION			

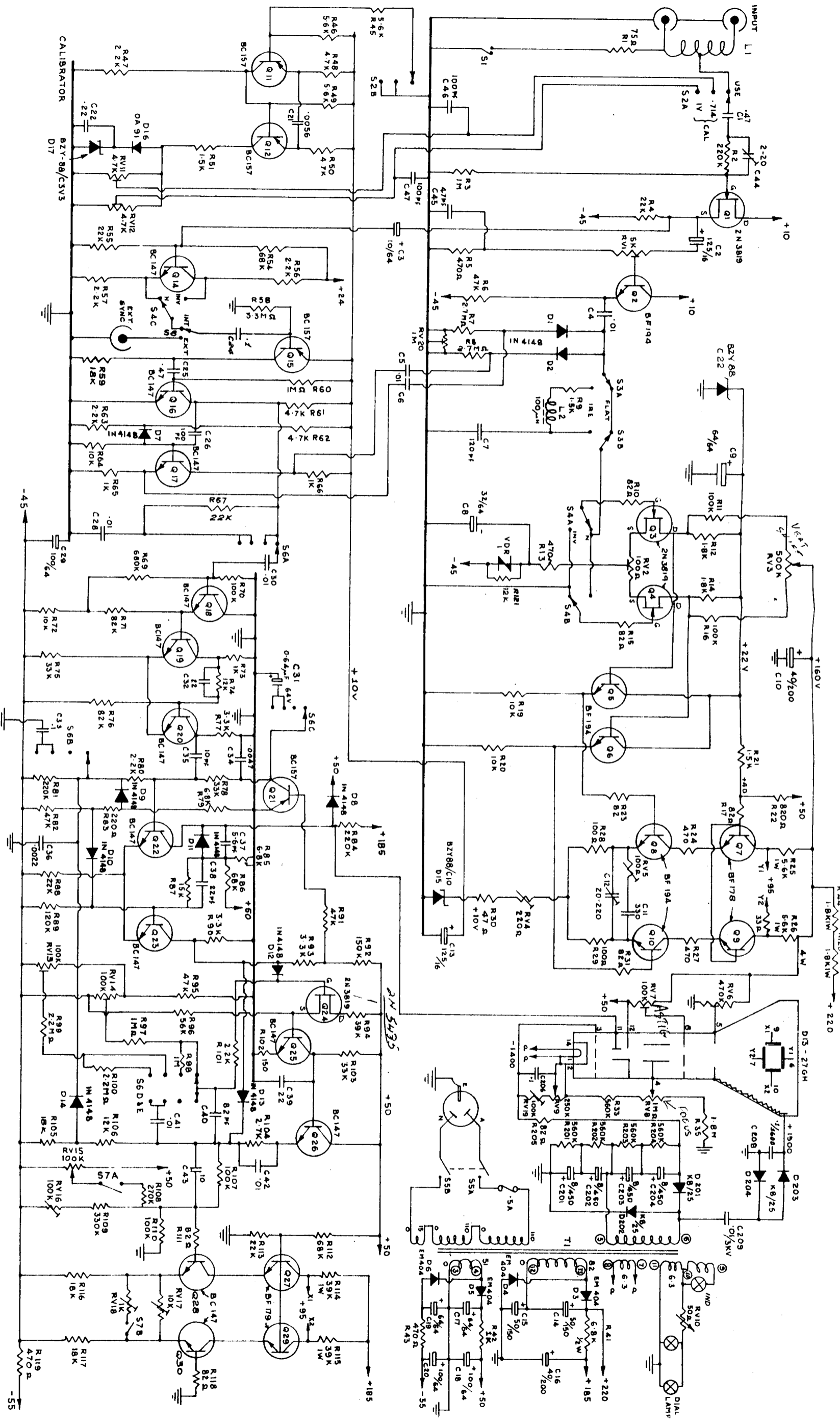

NOTE :-
COMPONENT VALUES MAY OCCASIONALLY VARY FROM THOSE
DESIGNATED DUE TO SUPPLY OR TO OPTIMISE PERFORMANCE

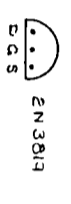

ISSUE	582	BWD ELECTRONICS P/L MELBOURNE AUSTRALIA	DRG. No.
DRAWN:			
TRACED:			
CHECKED:			
DATE:			
6		MODEL Bwd 582	825
871		VIDEO MONITOR	